



7/25/2022

# Pole Attachment Standards

## PURPOSE AND SCOPE

Medina Electric Cooperative (hereafter called “Medina EC”) will use reasonable efforts to provide safe, reliable, and adequate attachment space. To best accomplish this objective, Medina EC shall be contacted, and an Application submitted to Medina EC well in advance of your required attachment connection date. Available safety space, communications space and required clearances, etc. may vary at different locations.

The information contained in these Pole Attachment Standards (hereafter called “Standards”) refers primarily to technical joint use requirements for overhead joint use utility construction clearances and installation of communication cable and fiber optics cable. Pole attachment requirements for installations requiring other equipment are subject to negotiations between the Licensee and Medina EC.

Adherence to these Standards helps facilitate prompt service and inspection of all attachments, and further allows Medina EC to standardize its equipment, thereby allowing Medina EC to improve its services and better manage related costs.

These Standards are supplementary to the Licensee’s Pole Attachment License Agreement (“Agreement”), and the Medina EC Pole Attachment Permitting Procedures, and supersede all other standards previously issued and enforced in all areas served by Medina EC. These Standards are intended to provide reference for clearances between communications and power facilities but are not an official codebook. In the event a conflict should arise between the National Electric Safety Code (NESC), the National Electric Code (NEC), or any other applicable governing codes, the most applicable code will apply.



Contents

PURPOSE AND SCOPE ..... 1

1.0 Definitions .....3

2.0 General Requirements .....6

    2.1 Governing Standards.....6

    2.2 New Installation Compliance .....6

    2.3 Existing Installation Compliance .....6

    2.4 Overlash of Existing Installations .....6

    2.5 Maintenance of Existing Installations .....6

    2.6 Removal of Existing Installations .....7

    2.7 Attachment Work in the Supply Space .....7

    2.8 Adding New Poles for Attachments.....7

    2.9 Attachments to Non-Wood Poles.....7

    2.10 Transfers .....8

    2.11 Pole Loading Analysis.....8

3.0 COMMUNICATIONS LINE ATTACHMENT REQUIREMENTS .....9

    3.1 Attachment NESC Loading Requirements.....9

    3.2 Attachment Configurations and Tiering.....9

    3.3 Clearances ..... 11

    3.4 Attachment Height Transitions..... 11

    3.5 Attachment Hardware ..... 12

    3.6 Anchors and Guys ..... 12

    3.7 Slack Spans ..... 13

    3.8 Underground ..... 14

    3.9 Risers ..... 14

    3.10 Grounding ..... 14

    3.11 Tagging ..... 15

4.0 COMMUNICATIONS EQUIPMENT ATTACHMENT REQUIREMENTS ..... 16

    4.1 Definition of Communications Equipment ..... 16

    4.2 Installations on nearby non-MEC poles..... 16

    4.3 Pole Mounted Communications Equipment..... 16

    4.4 Non-Pole, non-Aerial Mounted Communications Equipment Locations..... 17

    4.5 Electric Service and Power Cable..... 17

    4.6 Emergency Electric Service Supply ..... 18

    4.7 Identification of Communication Enclosures ..... 18

    4.8 Abandoned Holes in a Pole ..... **Error! Bookmark not defined.**



## 1.0 Definitions

Italicized Definitions are also found in the Agreement or Pole Attachment Permitting Procedures

**Anchor & Guys:** A tensioned cable and accompanying assemblies designed to add stability to pole structures.

**Attachment:** Any Licensee's wire, line or apparatus attached to a Pole owned by Owner, including, but not limited to, cables, Service Drops, power supplies, amplifiers, pedestals, terminals, bonding wires, Over-Lashings, guy wires and anchors required to support unbalanced loads. A single Attachment includes the vertical space on the Pole 6" above and 6" below the point of contact; provided, however, that

- a) every through-bolt where the Pole is drilled and bolted to support cable and messenger qualifies as a separate Attachment without regard to separation;*
- b) J-hooks and bonding wires located within a space consisting of six inches (6") either above or below a through-bolt, shall not constitute separate billable Attachments;*
- c) a Pole mounted power supply will count as one additional billable Attachment;*
- d) Service Drops shall not count as additional billable Attachments so long as all such Attachments are contained within the one foot (1') of space six inches above or below a through-bolt. Multiple Service Drops where no through bolt exists, contained within one foot of space shall count as one billable Attachment; and*
- e) Over-Lashing, risers, vertical ground wires, and strand mounted facilities shall not be counted as additional billable attachments; and*
- f) guy wires, unless a sole attachment or drilled and bolted separately from its associated cabling shall not constitute an additional billable attachment.*

*Any other apparatus or facilities located fully or partly outside the one foot (1') vertical space shall constitute an additional Attachment or Attachments.*

**Application:** *The electronic application submitted by the Applicant through NJUNS requesting permission to install an Attachment on a Pole.*

**Climbing Space:** An unobstructed, vertical space along the side, or corner, of the pole away from the roadway. In general, it consists of an imaginary box, 30 inches square, extending at least 40 inches above the highest communications cable, or other facility, and 40 inches below the lowest communications cable, or facility. It may be shifted from any side, or corner, to any other side, or corner, not facing the roadway.

**Communication Space:** The space where horizontal communication facilities are separated from the supply space by the communication worker safety zone. This space is below the communication worker safety zone.



**Communication Worker Safety Zone (CWSZ):** That space as defined in National Electric Safety Code (NEC) Rule 235C4. This zone generally originates at the lowest point of the supply space. This space is intended to maintain a physical separation between supply and communications facilities. The minimum dimensions of this space shall at no time be violated. Medina EC reserves the right to the use of the CWSZ as it deems necessary.

- Medina EC does not authorize the reduced CWSZ clearance listed in NEC Exception 1 of 235C2b(1)(b) in order to maintain personnel safety and wildfire mitigation.
- All Medina EC supply facilities shall be treated as ungrounded and uncovered when determining NEC rule 238 clearances.

**Dead-End Pole:** A pole at the end of a straight section of utility line where the line ends or angles off in another direction

**Distribution:** Medina EC supply voltages of 12.47/7.2 kV and 24.94/14.4 kV

**Licensee:** A communications service provider to which Medina EC has granted certain non-exclusive rights to use its Poles, pursuant to the Licensee's signed Agreement.

**Lift Poles:** Pole structures installed to support secondary cable between transformer pole and point of service.

**Make-Ready or Make-Ready Work:** As defined in the Pole Attachment Permitting Procedures.

**Medina EC:** *Medina Electric Cooperative Inc.*

**NEC:** National Electric Code (Use Current Edition)

**NEC:** National Electric Safety Code (Use Current Edition)

**NJUNS:** *National Joint Utilities Notification System. The joint use notification system software currently used by Medina EC. Approved notification software is subject to change. Applicants will be informed of any changes.*

**Owner:** Medina EC

**Pole:** *Medina EC poles supporting electrical conductors of less than 69 kV; this does not include street light poles, guy poles, non-wood poles, and all other such special purpose poles or pole lines of non-standard design that do not support Medina EC's electrical distribution system. Use of non-wood poles and special purpose poles shall be at Medina EC's discretion.*

**Pole Attachment License Agreement:** *("Agreement") The Medina Electric Cooperative Pole Attachment License Agreement, together with all Addenda, Appendices, Medina EC's Pole Attachment Standards, and Pole Attachment Permitting Procedures.*

**Qualified Person:** A worker meeting all current training and experience requirements of all applicable federal, state, and local work rules, and of Licensee including but not limited to OSHA, for the type and nature of the work being performed. The Licensee shall assure that any person installing, maintaining, or removing its facilities is fully qualified and familiar with all applicable standards.



**Rearrangement:** Relocating or otherwise reconstructing an Attachment on the same Pole.

**Relocation:** Placement of existing Attachments on new Poles that may require splicing or other additional work beyond a simple Transfer.

**Riser:** Conduit on pole that supports transition from overhead to underground cables.

**Secondary:** Medina EC supply voltages of 600V, or less

**Slack Spans:** A reduced tension span that is itself not supported by anchoring and guying.

**Span Guy:** An aerial guying device supporting tension between two (2) pole structures.

**Supply Neutral:** Multi-grounded conductor of the distribution system

**Supply Space:** The upper portion of a distribution pole located above the communication worker safety zone, used to support electric cables and other electric equipment, such as transformers and capacitors, used for electric distribution. Only Medina EC Authorized electrical workers shall be allowed to work in or above the Supply Space.

**Support Space:** The space below the communication space where no horizontal communication line attachments can be made. Other Communications equipment may be attached here with Medina EC approval and subject to all other provisions of the Agreement, including rental rates.

**Tag:** Markers used to identify owners of Attachments.

**Tangent Pole:** A pole that is in a straight line with the poles on either side of it.

**Transfer:** *The removal of Attachments from one Pole and the placement of them, or substantially identical Attachments, upon another Pole in the same general area.*



## 2.0 General Requirements

### 2.1 Governing Standards

Licensee's Attachments shall at all times be in conformity with (1) requirements of the National Electrical Safety Code ("NESC") and subsequent revisions thereof; (2) all applicable Rural Utility Services (RUS) Standards as they apply to Licensee's Attachments and subsequent revisions thereof; (3) The Blue Book - Manual of Construction Procedures and subsequent revisions thereof; (4) where applicable, the Society of Cable Telecommunications Engineer's (SCTE) Recommended Practices for Coaxial Cable Construction and Testing and subsequent revisions thereof; (5) where applicable, the Society of Cable Telecommunications Engineer's (SCTE) Recommended Practices for Optical Fiber Cable Construction and subsequent revisions thereof; (6) Owner's Rules and Practices for Attachments found in these Standards and applicable revisions thereof; (7) National Electric Code (NEC) and subsequent revisions thereof; and (8) the lawful requirements of public authorities. Where there is a disagreement between the above referenced Specifications, the more stringent shall apply. It is understood by both parties that the requirements of the NESC are minimum requirements.

**2.1.1 Amendments:** Medina EC may amend its Standards for Attachments from time to time. Medina EC shall provide at least forty-five (45) days prior written notice to Licensee before the effective date of any such amendment. In the event Medina EC amends the rules and practices for Attachments set forth in these Standards, existing compliant Attachments shall be grandfathered unless otherwise agreed to by the Parties or prohibited by applicable law or regulation.

**2.1.2** Licensee shall install, at its own expense, protective devices designed to handle the voltage and current impressed on its communication facilities in the event of a contact or due to close proximity with supply conductors or other energized equipment.

### 2.2 New Installation Compliance

New installations shall be made in accordance with these Standards, Pole Attachment Permitting Procedures, and the Agreement.

### 2.3 Existing Installation Compliance

Existing installations, including maintenance replacements, which complied with the clearance requirements at the time of their original installation, are subject to the applicable terms of these Standards and the Agreement.

### 2.4 Overlash of Existing Installations

Overlapping of existing installations shall be governed by the terms of the currently executed Agreement, these Standards, and will require an approved attachment Application using Medina EC's Pole Attachment Permitting Procedures.

### 2.5 Maintenance of Existing Installations

Maintenance of existing installations shall be governed by the terms of the currently executed



Agreement, these Standards, and does not require written notice to Medina EC.

## 2.6 Removal of Existing Installations

Removal of existing installations shall be governed by the terms of the currently executed Agreement, these Standards, and will require an approved Application.

## 2.7 Attachment Work in the Supply Space

All work in the Supply Space (transfers, re-arrangement of facilities, Pole replacements, etc.) required for Licensee to attach its facilities shall be performed by Medina EC or a Medina EC approved contractor.

## 2.8 Adding New Poles for Attachments

New Poles shall be added as called for in the Pole Attachment Permitting Procedures for Make Ready as needed for Licensee to install Attachments.

## 2.9 Attachments to Non-Wood Poles

Medina EC will consider, but not necessarily allow attachments to non-wood distribution poles (i.e. concrete, steel, and fiberglass). Where such attachments are requested, the Licensee shall provide all information required by Medina EC for the completion of a detailed engineering analysis. The attachment will not be allowed if adequate information regarding the attachment, the existing facilities, or the pole is not provided or is unavailable.

**2.9.1 Metal Poles:** Attachment to metal distribution poles must be clamped or banded to the poles with Medina EC approved stainless steel straps. The drilling of holes in a metal pole for a bolt attachment is prohibited.

### 2.9.1.1 Refer to Standards Appendix A drawing MEC-19

**2.9.2 Fiberglass Poles:** Attachment to fiberglass poles should be treated like attachments to wood poles with the following exceptions:

2.9.2.1 Attachment to fiberglass poles must be made using through bolts for the hardware.

2.9.2.2 Lag screws are not permitted in fiberglass poles.

2.9.2.3 DO NOT drill the attachment hole at the same height as the pre-drilled climbing holes are located.

2.9.2.4 The attachment holes should have a minimum distance of 6 inches vertically from the pre-drilled holes.

2.9.2.5 DO NOT drill holes where the distance of the edge of that hole would be within 6 inches from the edge of any existing hole.



## 2.10 Transfers

2.10.1 All Transfers shall be in accordance with these Standards and the Agreement.

2.10.2 Licensee will be notified through NJUNS that a Transfer shall occur within thirty (30) days of notification of “next to go.”

2.10.3 Licensee will notify Medina EC in NJUNS that Transfers have been completed.

2.10.4 When Attachments are transferred to new Poles, Attachments must be tagged in accordance with the requirements of these Standards.

## 2.11 Pole Loading Analysis

2.11.1 Pole Loading Analysis will be performed for all new Attachments as stated in the Pole Attachment Permitting Procedures. Pole Loading Analysis is valid for six (6) months from the time of application submission. After that period, a new Pole Loading Analysis will be required.

2.11.2 Service drop attachments must be installed in compliance with all of the requirements of these Standards, the Pole Attachment Permitting Procedures, and the Agreement. This includes but is not limited to minimum clearances from the secondary voltage lines, the ground, signs, climbing space, and other obstructions.

2.11.3 The use of a drop terminal mounted to the Pole to feed multiple drops shall be counted as an additional Attachment and is subject to analysis and approval by Medina EC.





## 3.0 COMMUNICATIONS LINE ATTACHMENT REQUIREMENTS

### 3.1 Attachment NESC Loading Requirements

Communication line and equipment attachments shall be designed, constructed, and maintained in accordance with the NESC, including but not limited to, the clearance and strength/loading requirements. The following NESC loading requirements shall be evaluated with the loading case that provides the worst-case load governing:

Agency	Loading Condition	Temperature (°F)	Radial Ice Thickness (in.)	Wind Pressure (psf)	Where Applicable
NESC 250B	Light	30	0	9	All areas designated as light loading in the NESC
NESC 250C	Extreme Wind	60	0	NESC Figure 250-2	All structures or its supported facilities that exceed 60 ft. above ground line
NESC 250D	Extreme Ice with Concurrent Wind	15	.25 to .5	2.3	All structures or its supported facilities that exceed 60 feet above ground line. Ice thickness and wind pressure defined in geographical areas designated NESC Figure 250-3(a)

**3.1.1 NESC Grade B and C Construction:** As specified, except all Grade C construction shall comply with the requirements defined for Grade C “at crossing”.

**3.1.2 NESC 250B:** Light loading.

**3.1.3 NESC 250C:** Where a structure or its supported facilities exceed 60ft above ground or water level the structure and its supported facilities shall be designed to withstand the extreme wind load associated in the Basic Wind Speed as specified by NESC figure 250-2. Refer to NESC 250C to meet all other requirements of the Rule.

**3.1.4 NESC 250D:** Extreme Ice with concurrent wind loading, where applicable. See NESC loading zones. Refer to NESC 250D to meet all other requirements of the Rule.

### 3.2 Reserved Capacity

**3.2.1 MEC** shall require reserved capacity for any new or replaced poles as follows: Single Circuit - 10%; Double Circuit - 15%.



## 3.3 Attachment Configurations and Tiering

3.3.1 Medina EC reserves the right to have the top communication location (immediately below the CWSZ) for their communication cables where applicable.

3.3.2 The preferred order of attachments from highest to lowest position on the pole is as follows:

- Medina EC Fiber
- Communications Fiber
- CATV coaxial cable / copper conductor
- Telco copper

This is to reduce the chance of mid span contacts. However, if existing facilities make achieving that order impractical, Medina EC will utilize an order that still meets the requirements of this guide and all applicable governing codes.

3.3.3 Pole attachments (including lines, risers, and all equipment) shall be installed in a configuration which complies with these Standards and Medina EC's requirements for maintaining Climbing Space and Supply Space.

3.3.3.1 Any existing communication attachment violations on a pole shall have a corrective make ready solution for compliance included in the Application

3.3.3.3 Refer to Standards Appendix A drawing MEC-2

3.3.4 Any in-span service drop or device mounted on a communication cable or messenger must be a minimum of 15 inches from the pole face at its nearest point to assure adequate climbing space.

3.3.5 Communications lines shall not be installed in the supply space

3.3.6 Any Communication line passing within 36 inches of a pole must be attached to the pole.

3.3.6.1 Effectively grounded communication cable facilities passing near a Medina EC structure without being attached thereto shall have a horizontal clearance, without wind, from any part of such structure of not less than three feet.

3.3.6.2 Ungrounded communication cable facilities shall have a horizontal clearance, without wind, from any part of such structure of not less than five feet (per NESC Rule 234B).

3.3.7 Communication lines shall be arranged vertically and mounted directly to the Pole. Placement of new communications lines on two or more sides of a pole (boxing) is not permitted.

3.3.7.1 **Poles with No Current Attachments:** New Attachments shall always be made on the neutral side of the pole.

3.3.7.2 **Poles with Existing Non-Boxed Attachments:** New attachments shall always be made on the same side of the Pole as the existing Attachments.



**3.3.7.3 Poles with Existing Boxed Attachments:** If a Pole already has Supply and/or communication lines installed on opposite sides of the Pole (i.e. the Pole is boxed), the new line Attachment shall always be made on the neutral side of the pole.

3.3.8 Crossarms, extension arms, and standoff brackets shall not be utilized without Medina EC approval.

## 3.4 Clearances

3.4.1 Clearance between Medina EC electrical facilities and communication cable facilities must be in accordance with these Standards. Diagrams provided in Appendix A are intended as illustrative examples and are not comprehensive nor supersede more restrictive requirements of the section 2.1 Governing Standards.

3.4.2 Vertical clearances must be measured surface-to-surface, not center-to-center. Diagonal measurements do not apply to electrical clearances. Additional vertical clearance may be needed on the Pole to achieve the required in-span clearances. Any device that increases the profile of the communications cable, like communication reinforcing straps, should be considered when measuring vertical clearances between communication facilities and electrical facilities.

- Medina EC does not authorize the reduced CWSZ clearance listed in NESC Exception 1 of 235C2b(1)(b) in order to maintain personnel safety and wildfire mitigation.
- All Medina EC supply facilities shall be treated as ungrounded and uncovered when determining NESC rule 238 clearances.

3.4.3 The minimum clearance between two communication cables (surface-to-surface) supported by different suspension strands must be 12 inches at the pole and 6 inches mid-span.

**3.4.3.1 Expansion Loops on non-Fiber Optic communications Cables:** A minimum vertical clearance of 6 inches (surface-to-surface) must be maintained between any strand-mounted equipment of metallic conductor (e.g. coaxial, triaxial, etc.) cable expansion loops and the communication cables below. Reinforcing straps should not be considered when measuring clearances at the pole between communication cable facilities.

**3.4.3.2 Refer to Standards Appendix A drawing MEC-3.**

3.4.4 The vertical clearance for communication cables facilities above ground and paved surfaces at the low point in the span must be in accordance with NESC Table 232-1, local, and state regulations, whichever is the most restrictive.

3.4.5 Refer to Standards Appendix A drawings MEC-4A through MEC-10

## 3.5 Attachment Height Transitions

3.5.1 Transitioning attachment height on the same pole should be avoided. All same pole transitions must be reviewed and approved before construction.

3.5.2 Communication line arrangement shall continue a minimum of 20 spans before additional transition points to avoid excessive guying and congestion.



3.5.3 Vertical communication riser cable(s) shall be covered with an approved non-metallic material.

3.5.4 Both bottom and top transition points must be guyed to offset unbalanced load.

3.5.5 Refer to Standards Appendix A drawings MEC-11 and MEC-12

### 3.6 Attachment Hardware

3.6.1 Pole attachments shall be made with galvanized bolted connections in a permanent manner. Attachments utilizing stainless steel banding will only be allowed with prior approval by Medina EC.

3.6.2 Emergency attachment of communication lines on poles with tangent construction can be completed with the use of a j-hook. This shall only be considered a temporary attachment, not a long term/permanent solution.

3.6.3 Through bolt ends shall not protrude more than two inches beyond the attachment hardware attaching the hardware.

3.6.4 Licensee shall treat all abandoned holes with an industry acceptable wood preservative and repair such facilities as reasonable and appropriate. All holes in wood poles shall be plugged with treated wood doweling with a diameter of one-sixteen ( $1/16^{\text{th}}$ ) inch greater than the diameter of the hole.

### 3.7 Anchors and Guys

3.7.1 Medina EC anchors and guys shall only be used for Medina EC equipment. Each Licensee shall install independent guys and anchors for their respective facilities.

3.7.2 All anchors and guys shall be installed prior to installation of any messenger wire or cable.

3.7.3 All down guys, head guys, or messenger dead ends installed shall be attached to Poles by using through bolts. Attachment of down guys to the Pole with banding is prohibited.

3.7.4 Any time a messenger wire or cable changes directions, or dead ends, an anchor and guy is required.

3.7.5 The clearance ( surface to surface) between adjacent guying attachments or between adjacent communication facility and guying attachments should not be less than six inches.

3.7.6 Guy markers shall be installed as required by the NESC

3.7.7 Anchor rods shall extend a minimum of 6 inches above grade.

3.7.8 The top hole of the guy plate shall be 6 inches from the bottom hole of the mounting hardware supporting the tension load.

3.7.9 Standard Down Guys and Anchors



3.7.9.1 Every effort should be made to install anchors with a horizontal spacing of 8 feet. However, a minimum horizontal spacing of 5 feet can be used in situations where the horizontal spacing must be reduced. When 5 feet of horizontal spacing is unavailable, the horizontal spacing may be reduced to 3 feet provided the supply anchor is installed a minimum of 5 feet vertically beneath the communication anchor measured in-line with the anchor rod (**See Detail A of drawing MEC-13**). When the spacing is reduced to 3 feet a new supply anchor shall be installed before the communication anchor at Licensee's expense.

3.7.9.2 Communication anchors should achieve a minimum ratio of 2:1 for height to lead length.

3.7.9.3 Refer to Standards Appendix A drawing MEC-13

### 3.7.10 Sidewalk Guys and Anchors

3.7.10.1 Sidewalk Guys and Anchors are a non-preferred method and require prior approval by Medina EC.

3.7.10.2 Every effort should be made to install anchors with a horizontal spacing of 5 feet. When 5 feet of horizontal spacing is unavailable, the horizontal spacing may be reduced to 3 feet provided the supply anchor is installed a minimum of 5 feet vertically beneath the communication anchor measured in-line with the anchor rod (**See Detail A of drawing MEC-14**). When the spacing is reduced to 3 feet a new supply anchor shall be installed before the communication anchor at Licensee's expense.

3.7.10.3 No Sidewalk Communication anchor shall be installed closer than 6 feet from the surface of the pole.

3.7.10.4 Refer to Standards Appendix A drawing MEC-14

3.7.11 **Dead-Ends:** At dead-ends with spans in each direction from the dead-end structure, the unbalanced pull used to design the structure shall not be the difference in tensions. Rather guys shall be set on both sides as if the other conductor was not present.

3.7.12 All anchoring and guying is subject to changes by Medina EC personnel.

## 3.8 Slack Spans

3.8.1 Medina EC reserves the right to not allow the attachment of slack spans to a pole, or to require a larger ANSI pole classification than required by the standards. The decision will be based on project specifics including, but not limited to, Pole condition, Pole and line configuration, size and quantity of existing and proposed supply and communications lines.

3.8.2 No more than two (2) communication slack span lines shall be installed on a pole.

3.8.3 Communication slack span lines will only be permitted on Medina EC poles which are not leaning or bowed. In addition, Medina EC poles must have the required guys and anchors installed.

3.8.4 Maximum communication slack span line length is 100 feet. Maximum communication slack



spans are limited to one span per lead.

3.8.5 Communication slack span line requirements apply to original bundle and over-lashed lines.

3.8.6 Communication slack spans are subject to restriction based on results of pole loading analysis.

### 3.9 Underground

3.9.1 Any underground communication line in the same trench as Medina EC facilities must be in accordance with Medina EC's "Underground Unit Descriptions and Details: Appendix A" specification. A copy can be requested by contacting Medina EC at 1-866-632-3532.

### 3.10 Risers

3.10.1 Poles selected for attaching communications equipment shall be bucket truck accessible.

3.10.2 Underground pole attachments and risers must be placed on the pole side facing the roadway.

3.10.3 The number of underground (UG) electric and communication cable risers attached directly to the pole surface should be limited so that one side (180 degrees) of the pole is kept clear for climbing space and replacing the pole. No more than three risers (including cable not installed in conduit) may be installed on a pole.

3.10.4 A vertical run of communication cable attached to the pole surface should be covered with a suitable non-metallic material and must maintain acceptable clearance from through bolts or other metallic objects associated with Medina EC equipment. Acceptable clearance is equal to one-eighth the pole's circumference, or two inches, whichever is greater.

3.10.5 If existing Poles are to be replaced, existing communication risers shall be transferred to new poles and brackets at Licensee's expense.

### 3.11 Grounding

3.11.1 All grounding shall be performed in accordance with the NESC.

3.11.2 Communication lines, messengers, down guys, sidewalk guys, equipment, and support arms shall be bonded to the pole ground with #6 soft drawn bare copper wire or copper weld and connectors suitable for the purpose on each pole. If an attaching company requires a separate bond and ground, it must be bonded to the grounding conductor at the base of the pole in accordance with the NESC. A minimum two-inch (2") clearance of air or wood between all hardware and ground wires shall be maintained. There must be at least four (4) bonds per mile with not more than fifteen hundred (1,500) feet between these bonding locations. Communication cable that is entirely dielectric (non- conductive) need not be bonded. The pole ground SHALL NOT be cut or damaged when connecting Licensee's ground. **Refer to Appendix A drawing MEC-15.**

3.11.3 Bonding should be provided between metallic supply and communication equipment when mounted on the ground and within six (6) feet of each other as called for in NESC 384.



3.11.4 Meter troughs, meter trough covers, and service conduit and hubs shall not be used for communication grounds.

## 3.12 Tagging

To facilitate identification of attachments to Medina EC Poles, tags shall be installed on all communication line and equipment Attachments at the time of installation. These requirements will assist in identifying and contacting the Attachment owner as needed.

3.12.1 Each tag shall include the Attachment owner's name or generally recognized company logo. The tag shall also include a contact telephone number. The attaching company may choose the method, color, material (non-metal), construction and dimensions of the tag as long as the following requirements are met:

- Tags to remain permanently affixed to the attaching company's facilities.
- Color and text must be designed to last a minimum of 5 years.
- The company name and contact number must be easily readable and visible from the ground. A minimum of ½ inch high lettering is required.
- Tags should be consistent in appearance for a given company throughout Medina EC service territory.
- Tag design shall be emailed to Medina EC to ensure that no two Attaching entities have the same design.

**Refer to Standards Appendix A drawing MEC-16**

3.12.2 Missing tags should be replaced as soon as possible.

3.12.3 Tags must be replaced when the company name and/or contact telephone number are no longer legible from the ground.

3.12.4 Tags for Communication lines shall be installed on all attachments at time of construction. Tags shall be replaced as soon as possible if a missing tag is identified. If/when a communication company rebrands to a new name or is acquired by another company. Tags shall be updated to the new name within one year.

3.12.5 Non-tagged Attachments previously in place prior to the effective date of the Agreement shall be identified and tagged by Licensee as regular or emergency work occurs, but no later than three (3) years after the execution of Agreement. For pre-existing, non-tagged Attachments, the first and last Attachment on each Pole line and every fifth (5) Attachment in between shall be tagged.



## 4.0 COMMUNICATIONS EQUIPMENT ATTACHMENT REQUIREMENTS

### 4.1 Definition of Communications Equipment

Communication equipment is defined as anything other than a horizontal or vertical communication line attachment.

### 4.2 Installations on nearby non-Medina EC poles

When equipment is to be installed on a non-Medina EC owned pole, the pole shall be installed parallel to the Medina EC pole at a minimum distance evaluated on a case-by-case basis from the nearest supply conductor by Medina EC.

If it is possible during the course of work for someone to move to, or place any objects, within 20 feet of an overhead electric distribution line (less than 50 kV) you must first notify Medina EC of that electric line, at least 48 hours in advance of beginning any planned work and arrange with Medina EC for permission to complete the work. It may be required to have lines de-energized, moved, or have other arrangements made.

#### 4.2.1 Refer to Standards Appendix A drawing MEC-17

### 4.3 Pole Mounted Communications Equipment

**4.3.1 New Equipment Approval:** Medina EC must approve any Pole chosen for the installation of all new cabinets and equipment cases prior to installation.

**4.3.2 Existing Equipment Relocation:** Medina EC may require the relocation of existing Licensee communication equipment to another Pole if room for new electrical service equipment is required.

**4.3.3 Acceptable Pole Mounting Locations:** Cabinets & equipment cases may be mounted directly on the Pole in the Support Space or suspended from the communication cable messenger. Enclosures to be mounted on a Medina EC Pole SHALL follow the requirements listed below:

- Mount in the same quadrant as the transformer or other Electric supply device.
- If no Electric supply device exists, mount enclosures in line with the overhead primary conductors and under the primary crossarm. In the absence of a crossarm, mount enclosure under the primary conductor, on the gain (i.e. flat surfaces for mounting) side of the pole.
- No closer than 5 inches from the surface of the pole.
- Licensee shall supply an additional 3 feet of conductor out of weather head for Medina EC to make final connection.
- The lowest point of equipment protruding over drivable surfaces shall be no lower than 16' or the minimum defined by the applicable governing standards, whichever is more restrictive.





**4.3.4 Prohibited Pole Mounting Locations:** Do not install any new pole-mounted cabinets and service entrance equipment on:

- Junction poles (a pole where the Medina EC primary line runs in three or more directions)
- Poles that are 60 feet and greater in size or made of metal
- Poles with cabinets already installed by any communication company. However, a new cabinet can be installed on a pole with an existing cabinet if both cabinets are owned by the same company, the new cabinet is part of a rebuild project and the existing cabinet will be removed upon rebuild project completion, and no other exclusion reasons (as listed above) exist.
- Poles with cabinets containing controls such as fire alarm, police signal, or traffic signal
- Poles with capacitor controls, regulator controls, recloser controls, air switch operating handles, switch handles, or an existing electrical service entrance
- Transformer poles which are not accessible to mechanized equipment
- Poles with underground electric or communication riser conduits which are not accessible to mechanized equipment
- Dead-end or Double Dead-end corner poles with or without anchors.

**4.3.5 Maximum Size:** The maximum size pole-mounted cabinet or equipment case allowed is 31 inches wide x 19 inches deep x 38 inches high. Climbing aids are required when cabinets larger than 30 inches high are installed. The climbing aid can be a 3/4-inch bolt approximately 22 inches long, projecting 8 inches from each side of the mounting channel, secured by four nuts at the channel, and mounted halfway up the channel. Cabinets must be mounted using externally accessible hardware.

**4.3.6 Maximum Weight:** Pole mounted communications equipment may be restricted dependent on the class and age of the pole per Medina EC's judgement. Pole mounted equipment is subject to restriction based on results of Pole Loading Analysis.

**4.3.7 Clearances:** The minimum vertical clearance from the top of the equipment case or cabinet to the lowest communication cable facility is 31 inches.

**4.3.8 Grounding:** The requirements of section 3.10 Grounding apply to all pole mounted equipment.

## 4.4 Non-Pole, non-Aerial Mounted Communications Equipment Locations

All non-Pole, non-Aerial mounted communications equipment shall be a minimum of 10 feet from the edge of a Medina EC pole.

**4.4.1 Refer to Standards Appendix A drawing MEC-18**

## 4.5 Electric Service and Power Cable

4.5.1 In the event Licensee requires a source of commercial electrical energy for any Attachment on or supported by any of Owner's Poles, Licensee will obtain such electrical connection from Owner. If requested, Owner will supply such energy in accordance with its standard service policies and rates and tariffs, and in recognition of any regulatory requirements. Any and all electrical connections made to Owner's electrical system will be performed by Owner, other than the placement of Licensee's Attachment to Owner's Pole and connecting to vertical ground wires located on Owner's Pole. In the event Licensee or its agents connects any device to Owner's electrical system, such



connection shall be considered a Default under the terms of this Agreement and Owner shall have the right to any and all remedies allowed by this Agreement. Further, Licensee shall pay (a) the estimated costs of energy consumed by such device, and (b) a charge of \$100 for the expense incurred by Owner in investigating, disconnecting, and estimating the costs of energy consumed. In addition to the remedies which are provided in this Agreement, Licensee is also subject to the terms of Owner's electric service requirements, including, but not limited to all terms related to theft of electrical service, and to any other remedies available to Owner at law or in equity.

4.5.1.1 Electric Service cannot be obtained from the street light photocell on distribution poles that have a streetlight installed

4.5.2 Power and communication cable assemblies attached on bracket arms shall be installed inside the arm.

4.5.3 Power conductors shall be insulated with a jacket enclosing the entire cable assembly.

4.5.4 The entire length of the power cable assemblies mounted on a pole shall be enclosed in Schedule 80 PVC conduit. Conduit diameter shall not exceed 2 inches. The conduit shall be attached to the pole every 5 feet.

## 4.6 Emergency Electric Service Supply

Generators or other means for emergency electric service to communication cable facilities are prohibited unless specifically approved by Medina EC. The type of device to be used must ensure that there cannot be an interconnection between the emergency electric supply and the Medina EC electric system.

## 4.7 Identification of Communication Enclosures

Licensees contacting Pole SHALL install and maintain non-corrosive durable tags, suitable for outdoor use and resistant to ultraviolet radiation at each pole to identify the same of the owner and a 24-hour emergency telephone number.

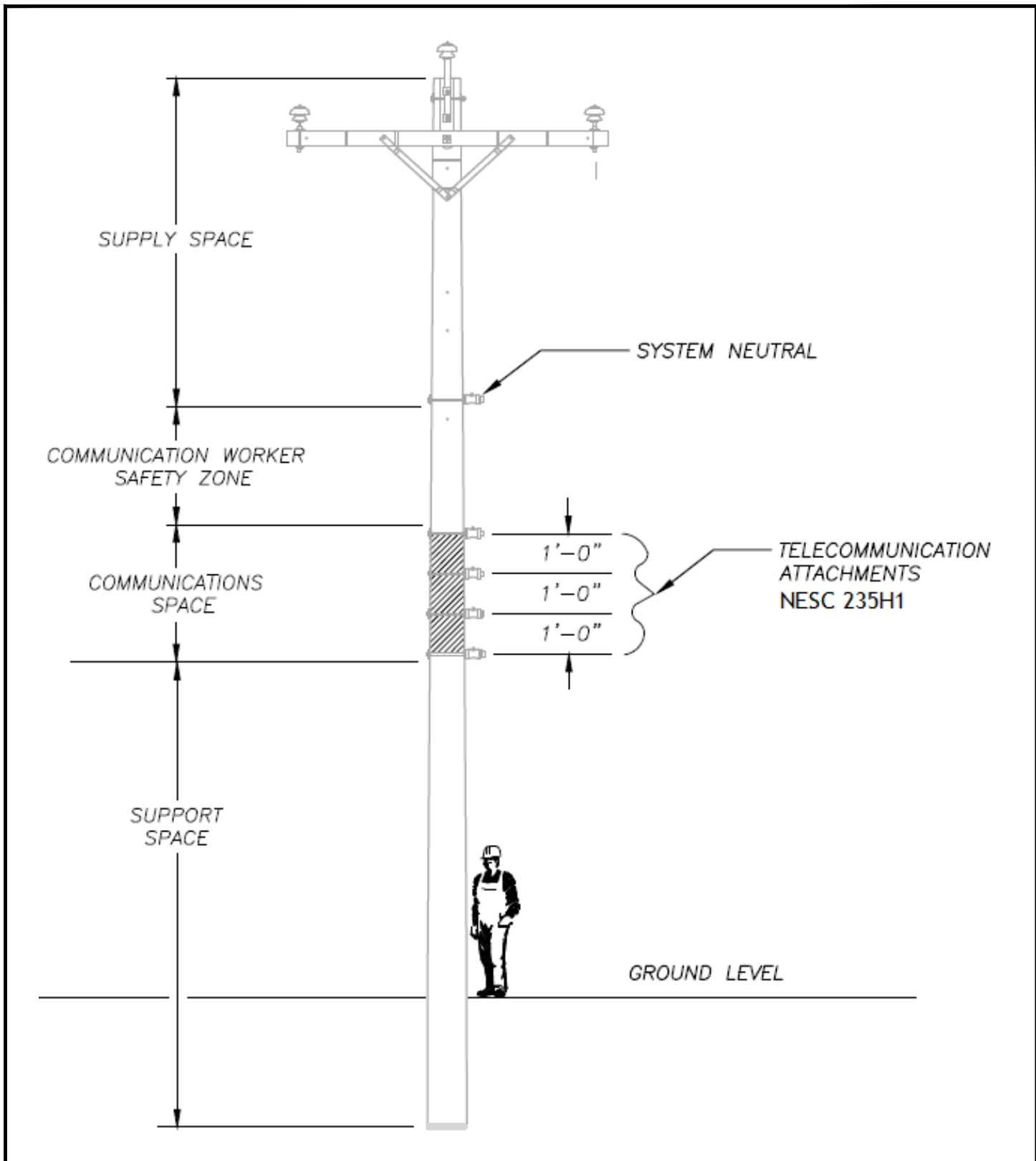

MEDINA ELECTRIC COOPERATIVE PO Box 370 Hondo, TX 78861	POLE SPACES DEFINED
--	---------------------

REV	DATE	REVISION DESCRIPTION	DESIGNER	REVIEWER	NOT TO SCALE
A	11/24/21	INITIAL	MAP	TAF	

	DRAWING #
	MEC-1

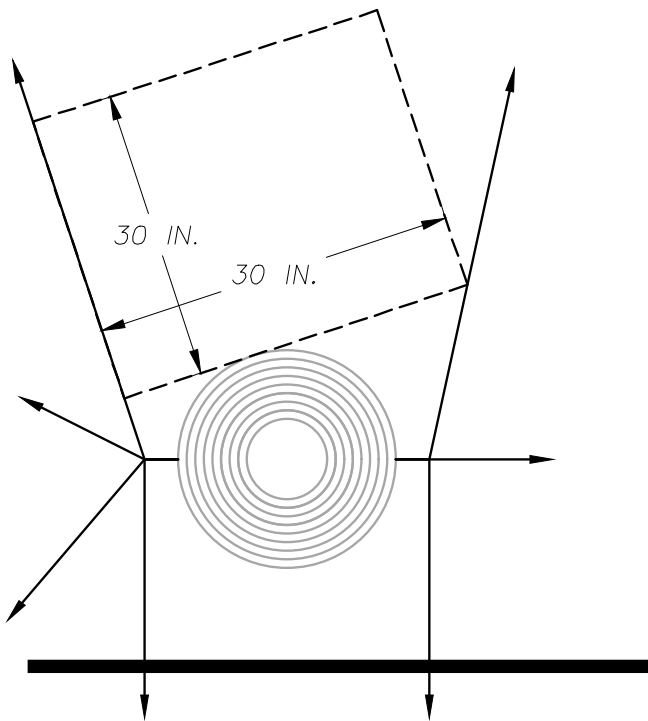
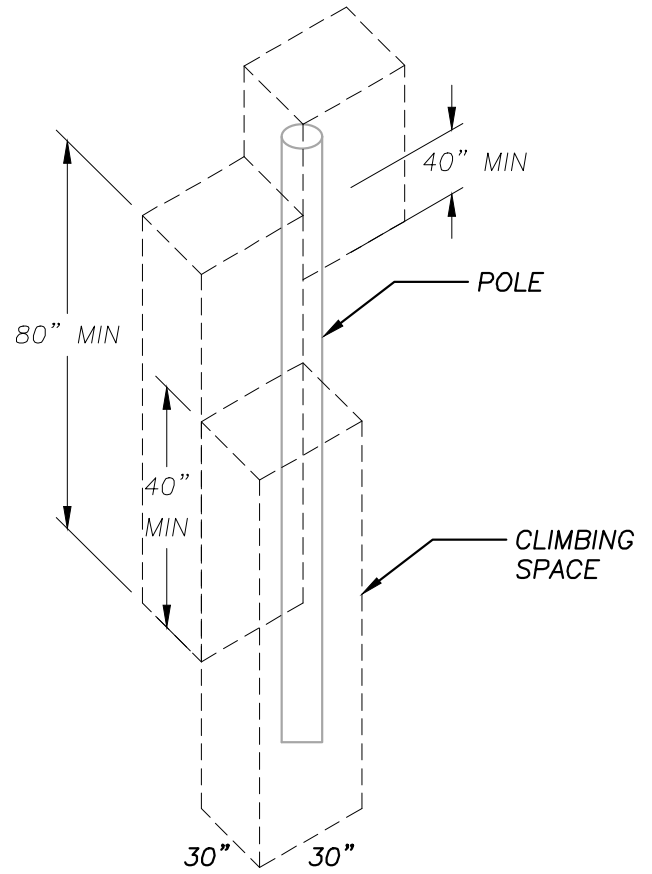

Climbing Space (NESC 236) is an unobstructed, vertical space along the side or corner of the pole. In general, it consists of an imaginary box, 30 inches square, extending at least 40 inches above the highest communication cable or other facility, and 40 inches below the lowest communications cables or other facility, but may be shifted from any side or corner to any other side or corner.

MEDINA ELECTRIC COOPERATIVE  
 PO Box 370  
 Hondo, TX 78861

MAINTAINING CLIMBING SPACE

REV	DATE	REVISION DESCRIPTION	DESIGNER	REVIEWER	NOT TO SCALE
A	11/21/24	INITIAL	MAP	TAF	



DRAWING #

MEC-2

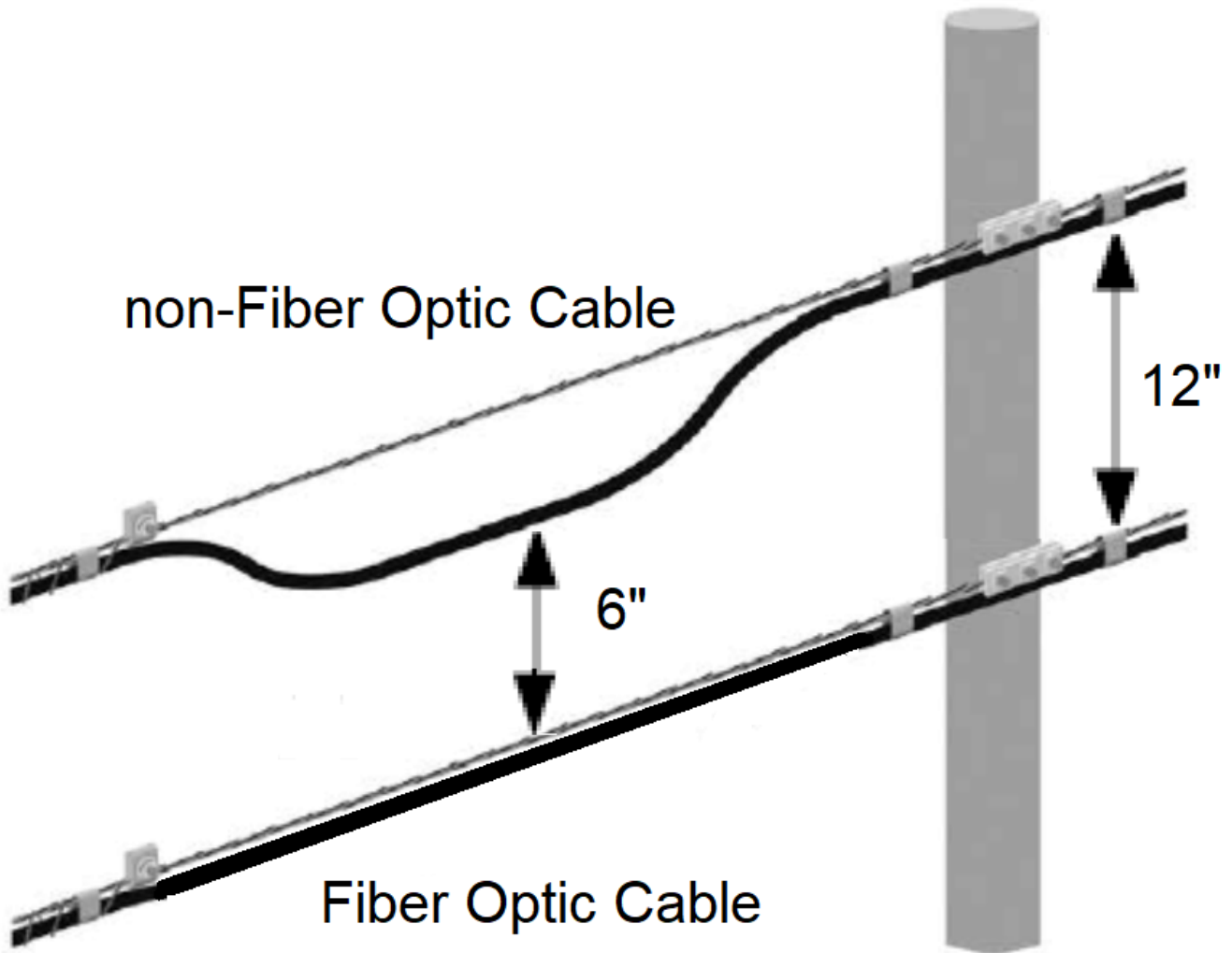

MEDINA ELECTRIC COOPERATIVE  
 PO Box 370  
 Hondo, TX 78861

EXPANSION LOOPS ON NON-FIBER OPTIC  
 COMMUNICATION CABLES

REV	DATE	REVISION DESCRIPTION	DESIGNER	REVIEWER	NOT TO SCALE
A	11/24/21	INITIAL	MAP	TAF	

DRAWING #

MEC-3

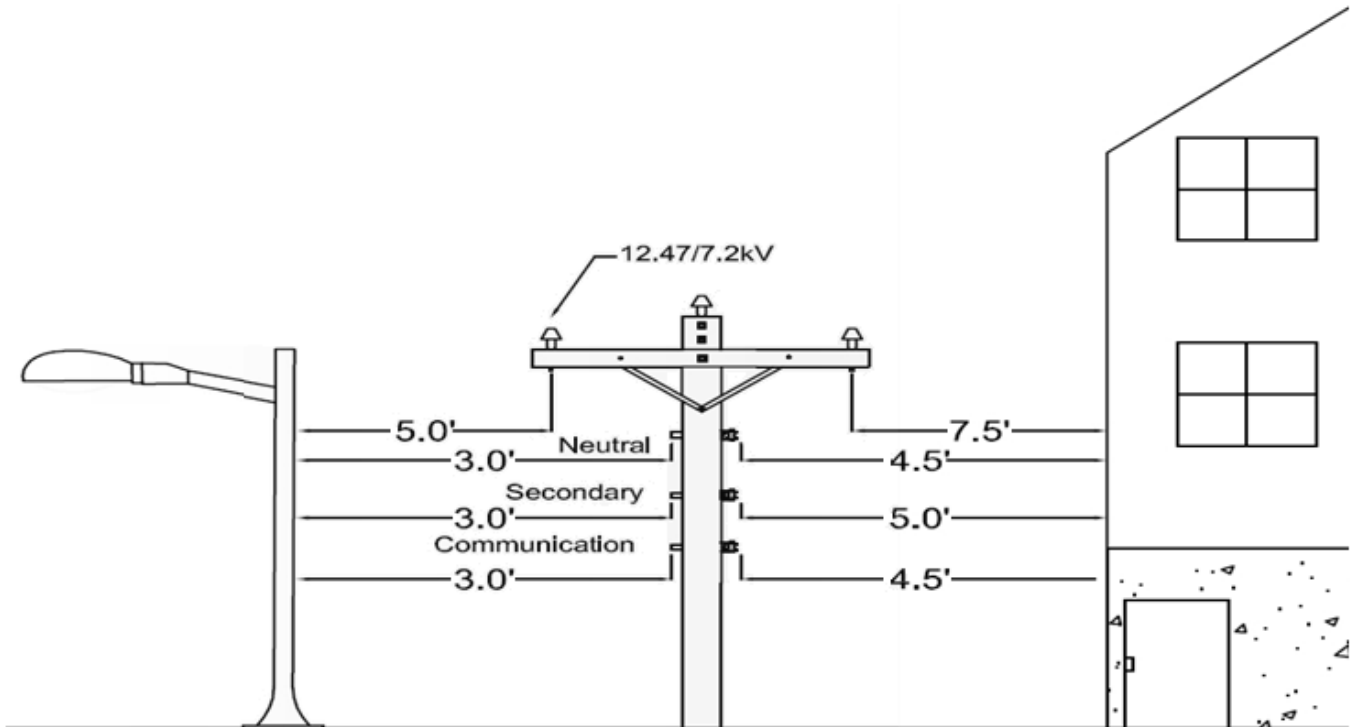
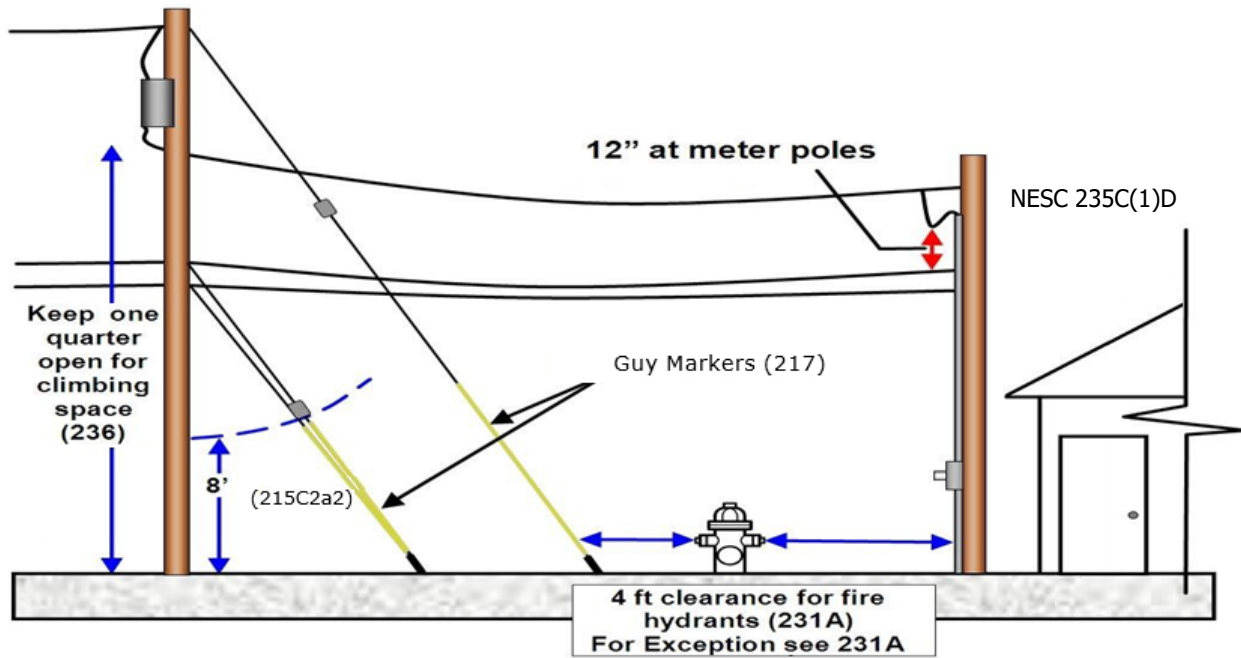

NESC 234 CLEARANCES TO OTHER STRUCTURES  
CABLES 300V OR LESS NEED TO BE A MINIMUM TWO FEET OVER THE STREET LIGHT

MEDINA ELECTRIC COOPERATIVE  
PO Box 370  
Hondo, TX 78861

NESC CLEARANCES TO COMMUNICATIONS CABLE  
SUMMARY

REV	DATE	REVISION DESCRIPTION	DESIGNER	REVIEWER	NOT TO SCALE
A	11/24/21	INITIAL	MAP	TAF	



DRAWING #

MEC-4A

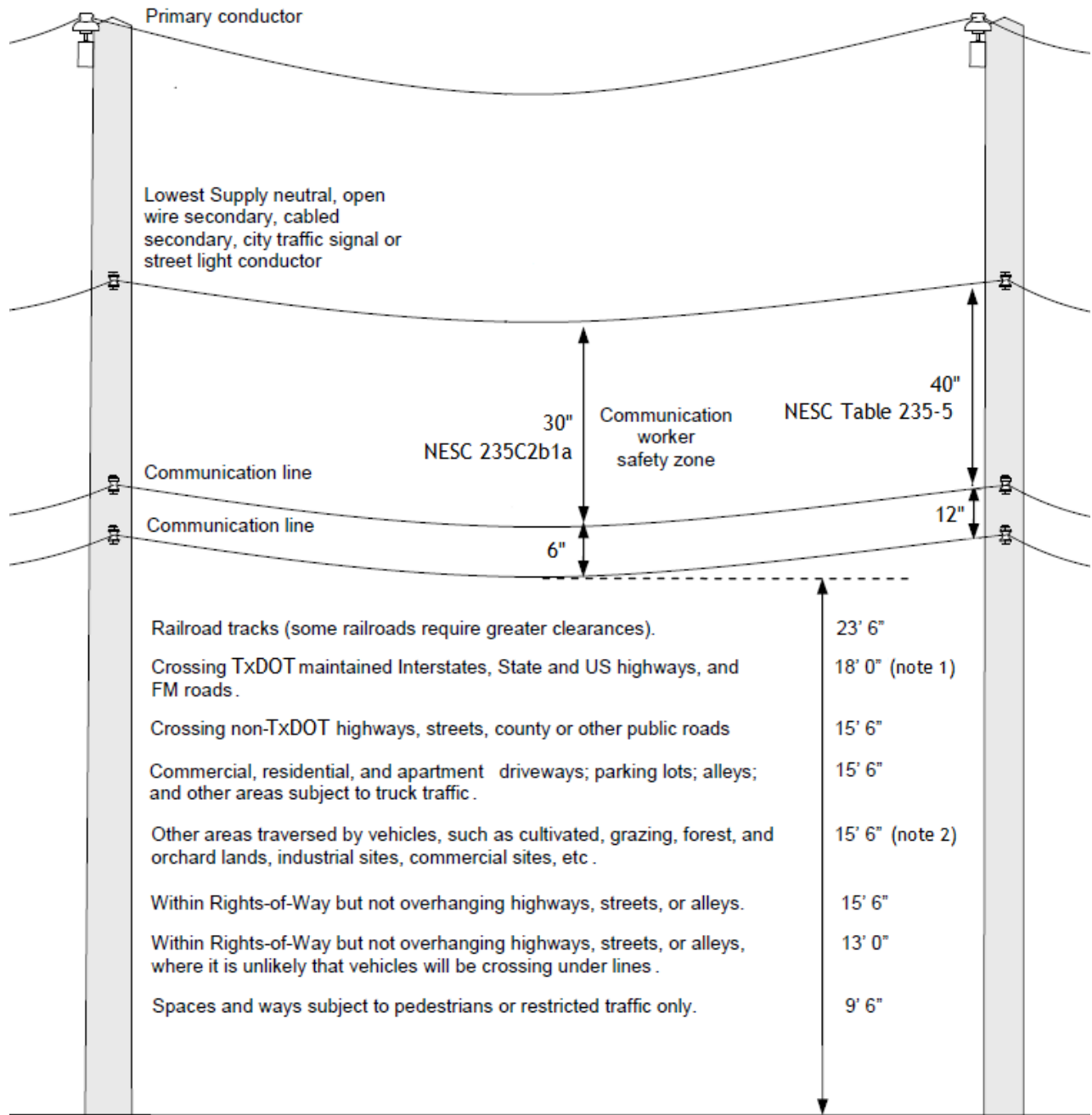

1. Contact the Texas Department of Transportation for their required clearances
2. To accommodate oversized vehicles, clearance values shall be increased by the difference between the known height of the vehicle and 14 feet at minimum.
3. Refer to NESC Table 232-1

MEDINA ELECTRIC COOPERATIVE PO Box 370 Hondo, TX 78861					NESC CLEARANCES TO COMMUNICATIONS CABLE SUMMARY	
REV	DATE	REVISION DESCRIPTION	DESIGNER	REVIEWER	NOT TO SCALE	
A	11/24/21	INITIAL	MAP	TAF		
					DRAWING #	
					MEC-4B	

CONSTRUCTION WITH  
LOW NEUTRAL

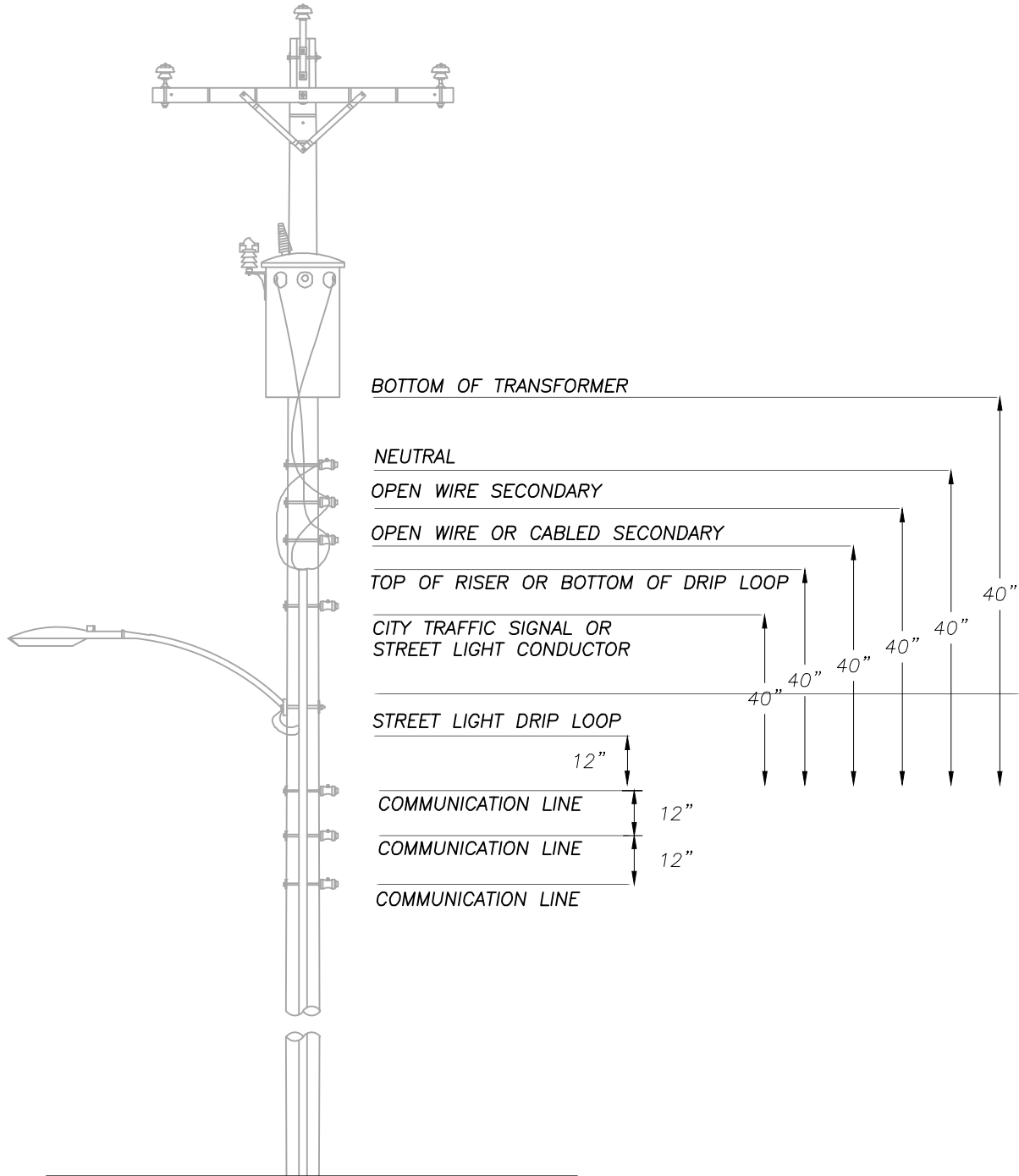

1. Clearances shown are minimum values in accordance with MEC requirements or the NESC. Additional clearance at the pole may be required to meet the minimum mid-span clearances.

MEDINA ELECTRIC COOPERATIVE PO Box 370 Hondo, TX 78861				SUPPLY AND COMMUNICATION CLEARANCES AT POLE	
REV	DATE	REVISION DESCRIPTION	DESIGNER	REVIEWER	NOT TO SCALE
A	11/24/21	INITIAL	MAP	TAF	
					DRAWING #
					MEC-5



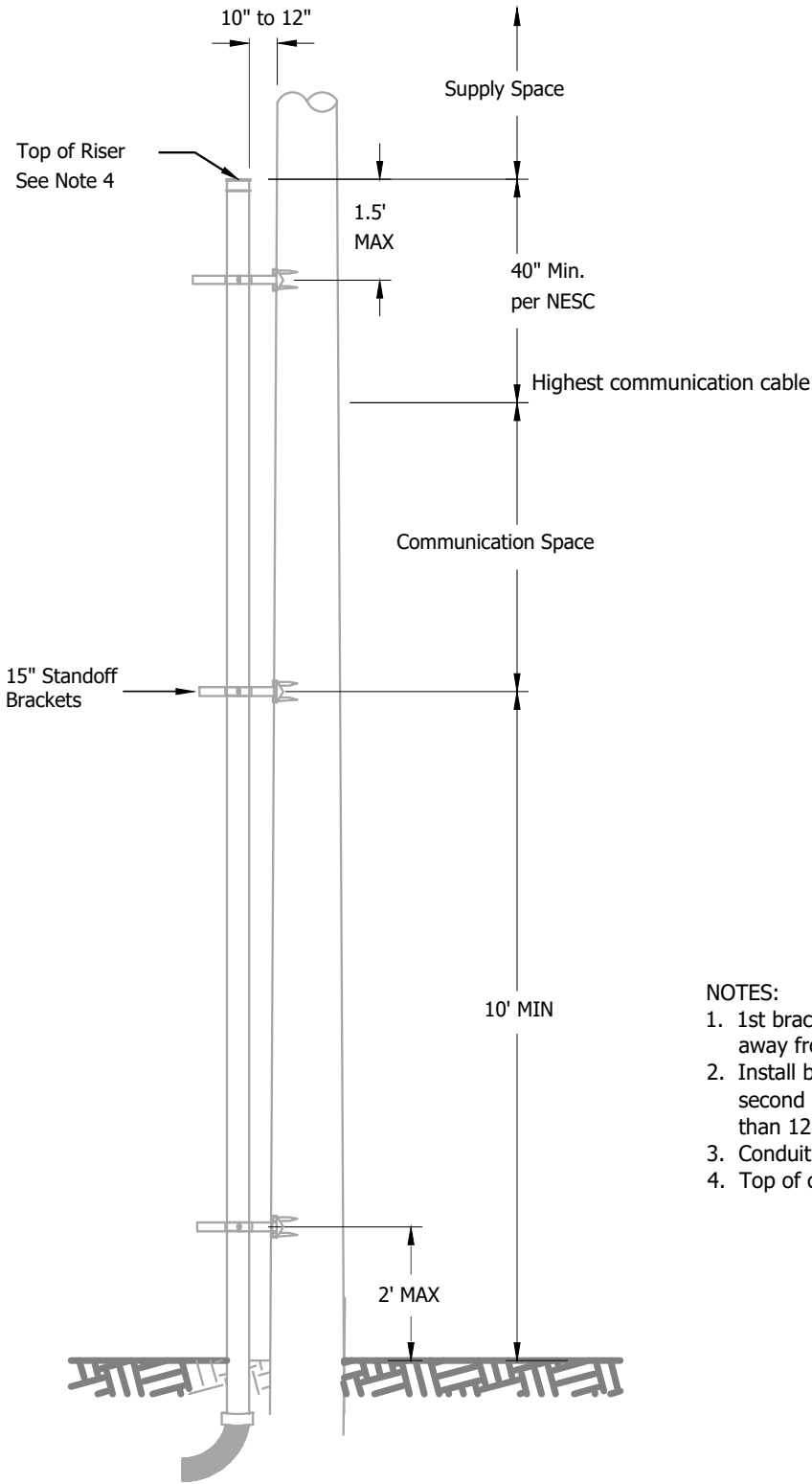

NOTES:

1. 1st bracket position riser conduit in line with power line away from traffic where possible.
2. Install brackets at a maximum of 2' from the ground, the second bracket is a minimum of 10' from the ground, less than 12' there after.
3. Conduit shall extend 24" into ground, minimum.
4. Top of conduit not lower than 6" below lowered neutral.

MEDINA ELECTRIC COOPERATIVE  
PO Box 370  
Hondo, TX 78861

CLEARANCE TO RISER

REV	DATE	REVISION DESCRIPTION	DESIGNER	REVIEWER	NOT TO SCALE
A	11/24/21	INITIAL	MAP	TAF	



DRAWING #

MEC-6

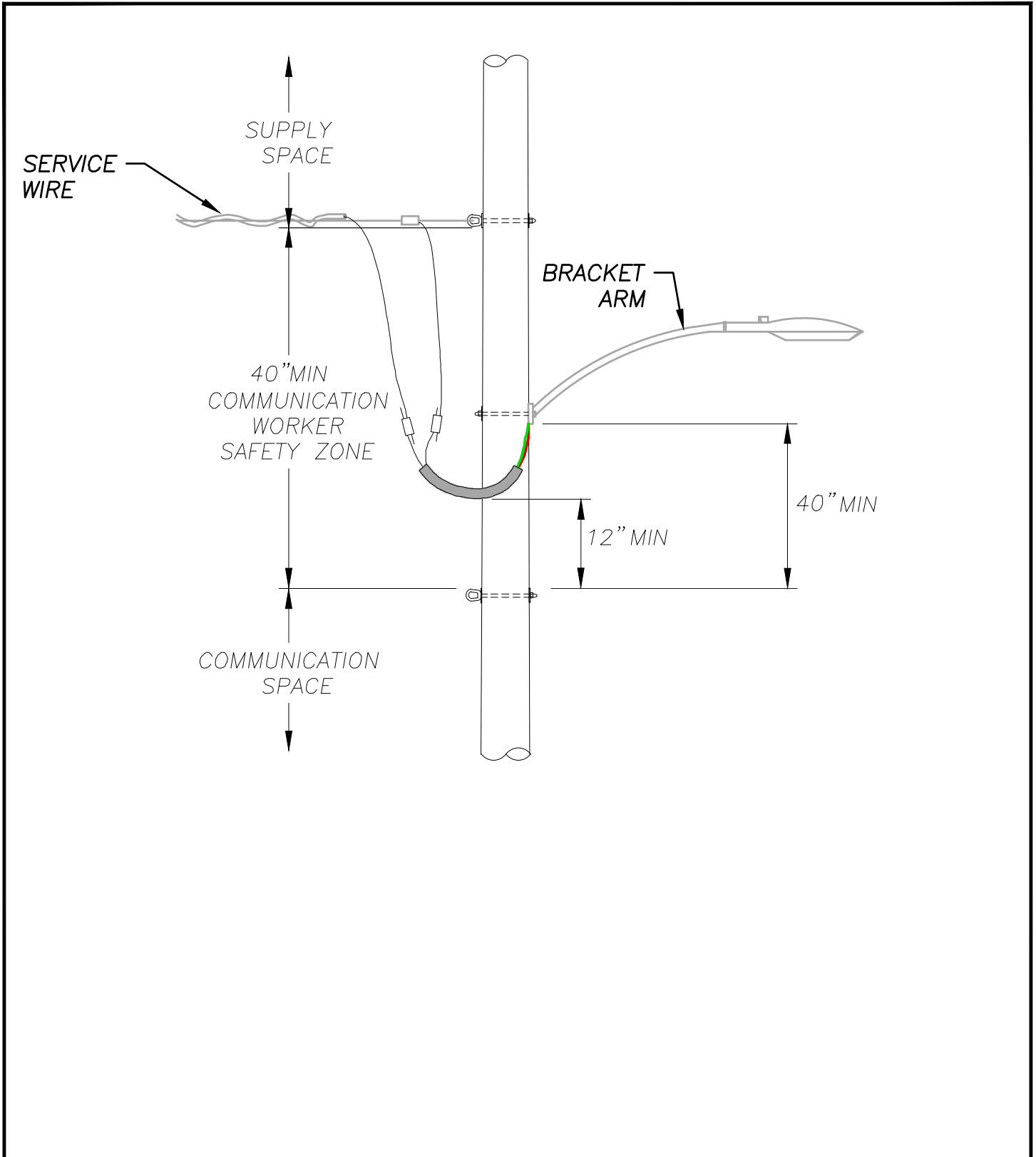

MEDINA ELECTRIC COOPERATIVE PO Box 370 Hondo, TX 78861					CLEARANCES FOR STREET LIGHTS ABOVE COMMUNICATIONS	
REV	DATE	REVISION DESCRIPTION	DESIGNER	REVIEWER	NOT TO SCALE	
A	11/24/21	INITIAL	MAP	TAF		DRAWING #
						MEC-7

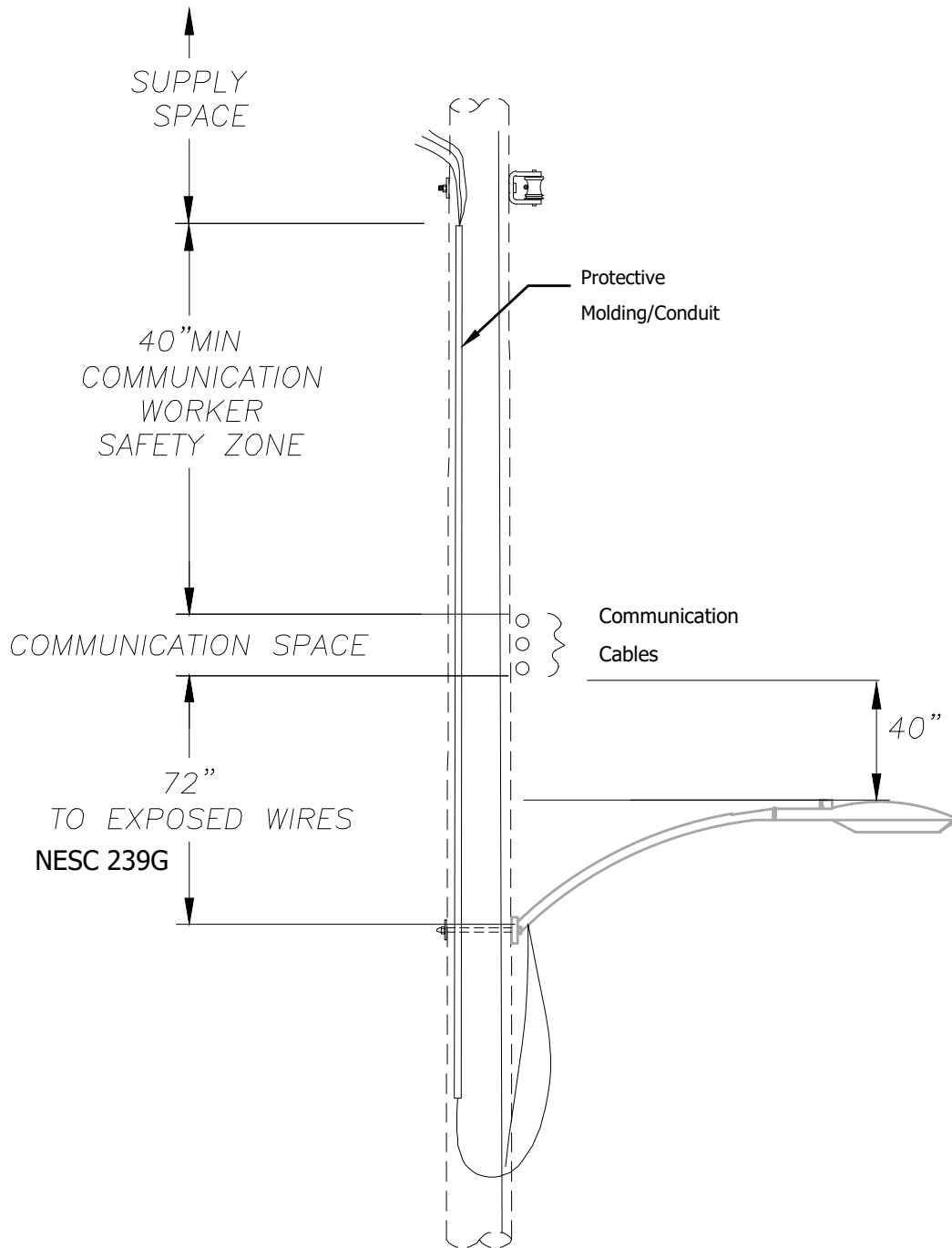

MEDINA ELECTRIC COOPERATIVE  
 PO Box 370  
 Hondo, TX 78861

CLEARANCES FOR STREET LIGHTS  
 BELOW COMMUNICATIONS

REV	DATE	REVISION DESCRIPTION	DESIGNER	REVIEWER	NOT TO SCALE
A	11/24/21	INITIAL	MAP	TAF	

DRAWING #

MEC-8

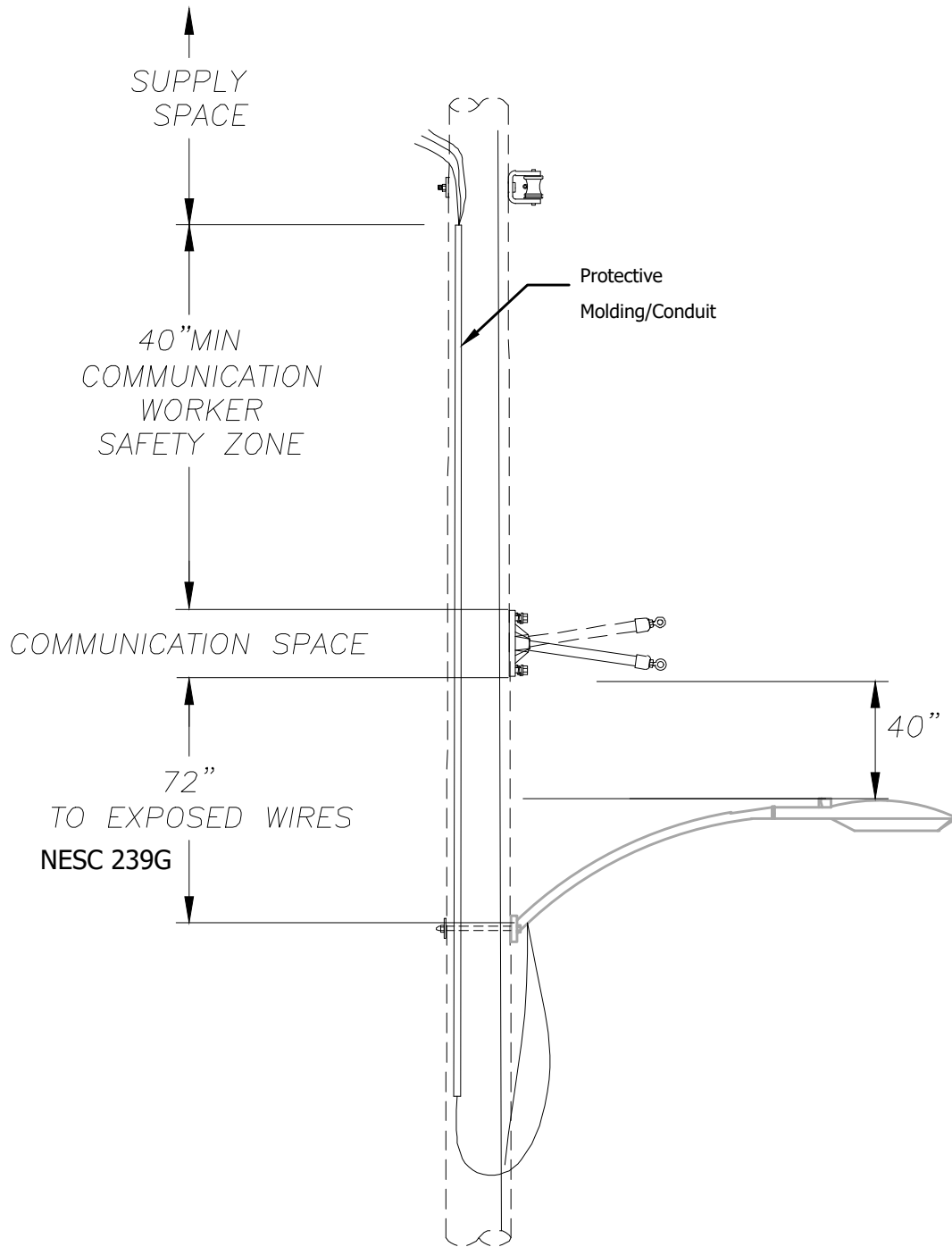

MEDINA ELECTRIC COOPERATIVE  
 PO Box 370  
 Hondo, TX 78861

CLEARANCES FOR STREET LIGHTS  
 BELOW COMM SUPPORT ARM

REV	DATE	REVISION DESCRIPTION	DESIGNER	REVIEWER	NOT TO SCALE
A	11/24/21	INITIAL	MAP	TAF	

DRAWING #

MEC-9

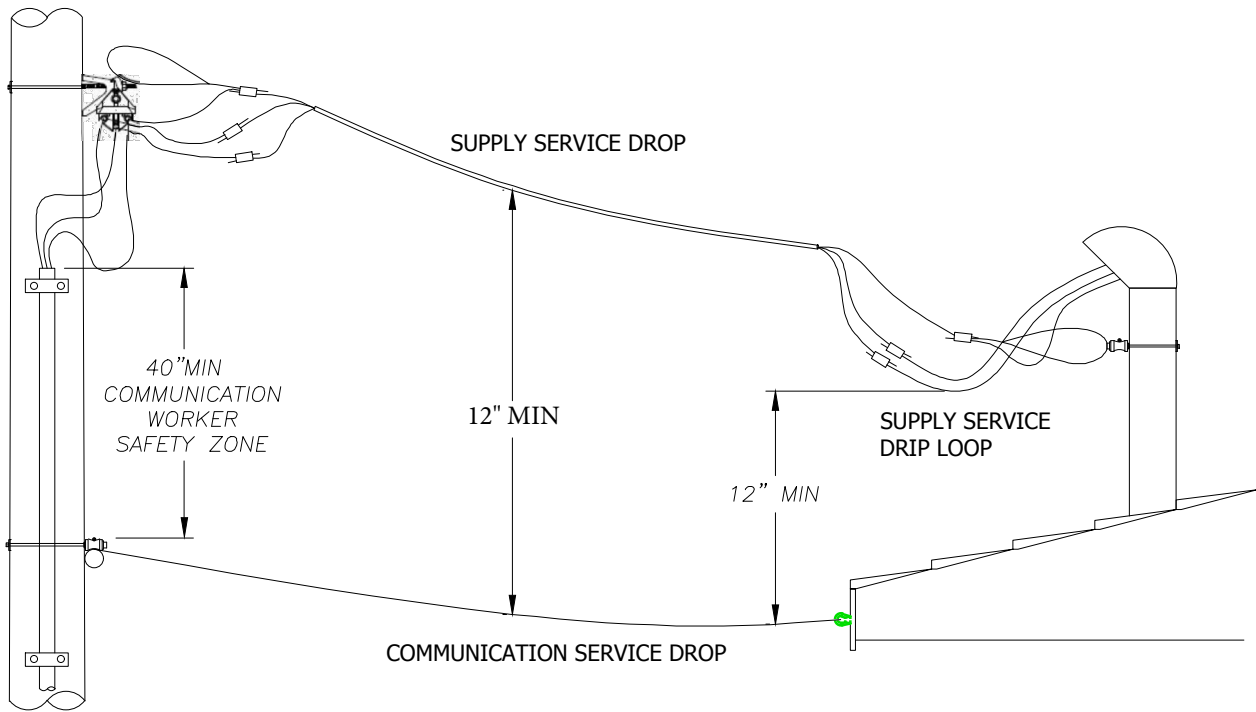

1. Minimum clearance of 12" between Supply (Less than 750V) and Communication service drops at service entrance and along entire length of the service in accordance with 235C1d.
2. Clearance shall be maintained between lowest of drip loop or top of riser and Communication service drop.

MEDINA ELECTRIC COOPERATIVE PO Box 370 Hondo, TX 78861					COMMUNICATION SERVICE DROP CLEARANCES	
REV	DATE	REVISION DESCRIPTION	DESIGNER	REVIEWER	NOT TO SCALE	
A	11/24/21	INITIAL	MAP	TAF		
					DRAWING #	
					MEC-10	

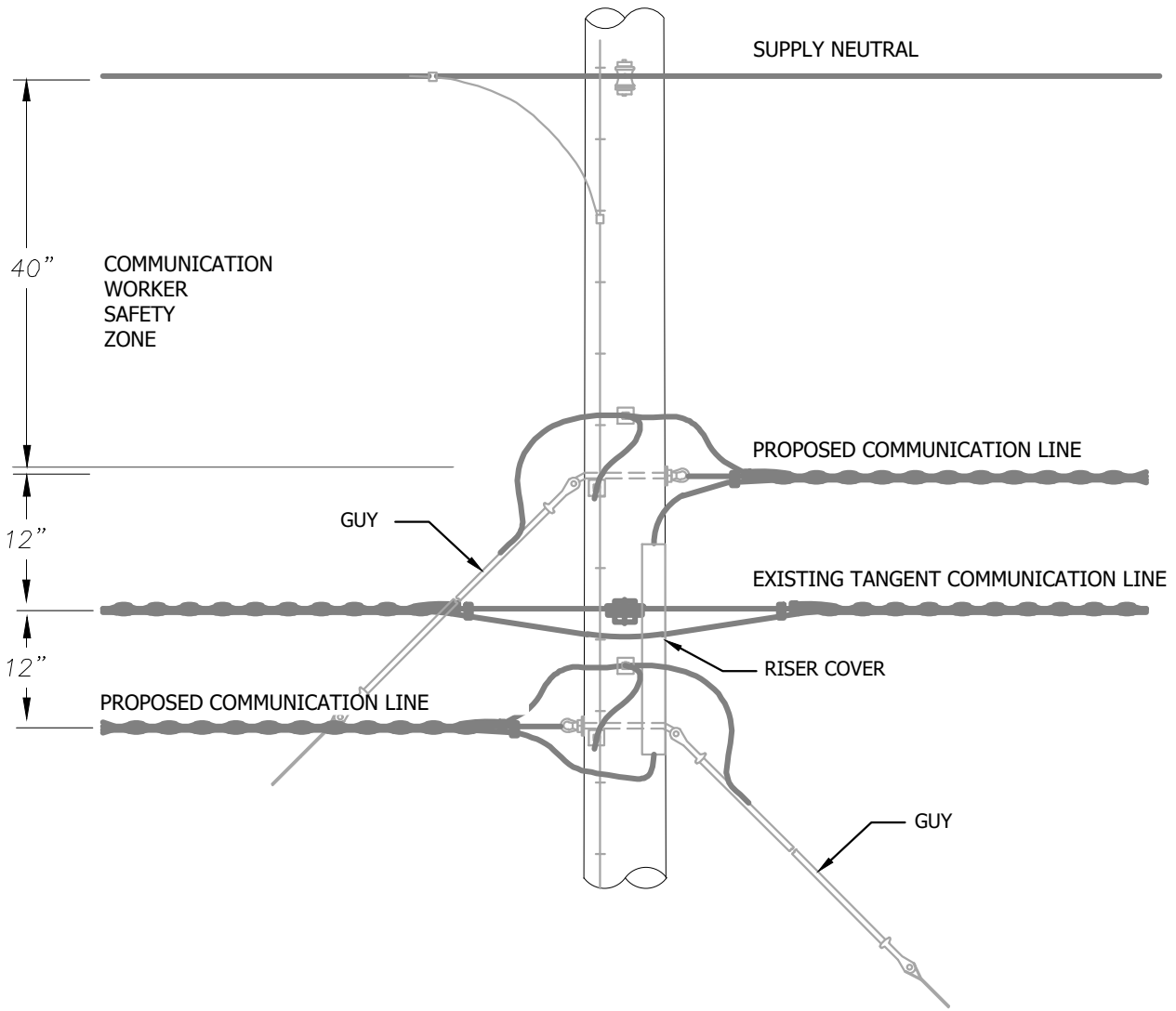

MEDINA ELECTRIC COOPERATIVE  
 PO Box 370  
 Hondo, TX 78861

COMM LINE TRANSITION  
 ON TANGENT POLE

REV	DATE	REVISION DESCRIPTION	DESIGNER	REVIEWER	NOT TO SCALE
A	11/24/21	INITIAL	MAP	TAF	

DRAWING #  
 MEC-11

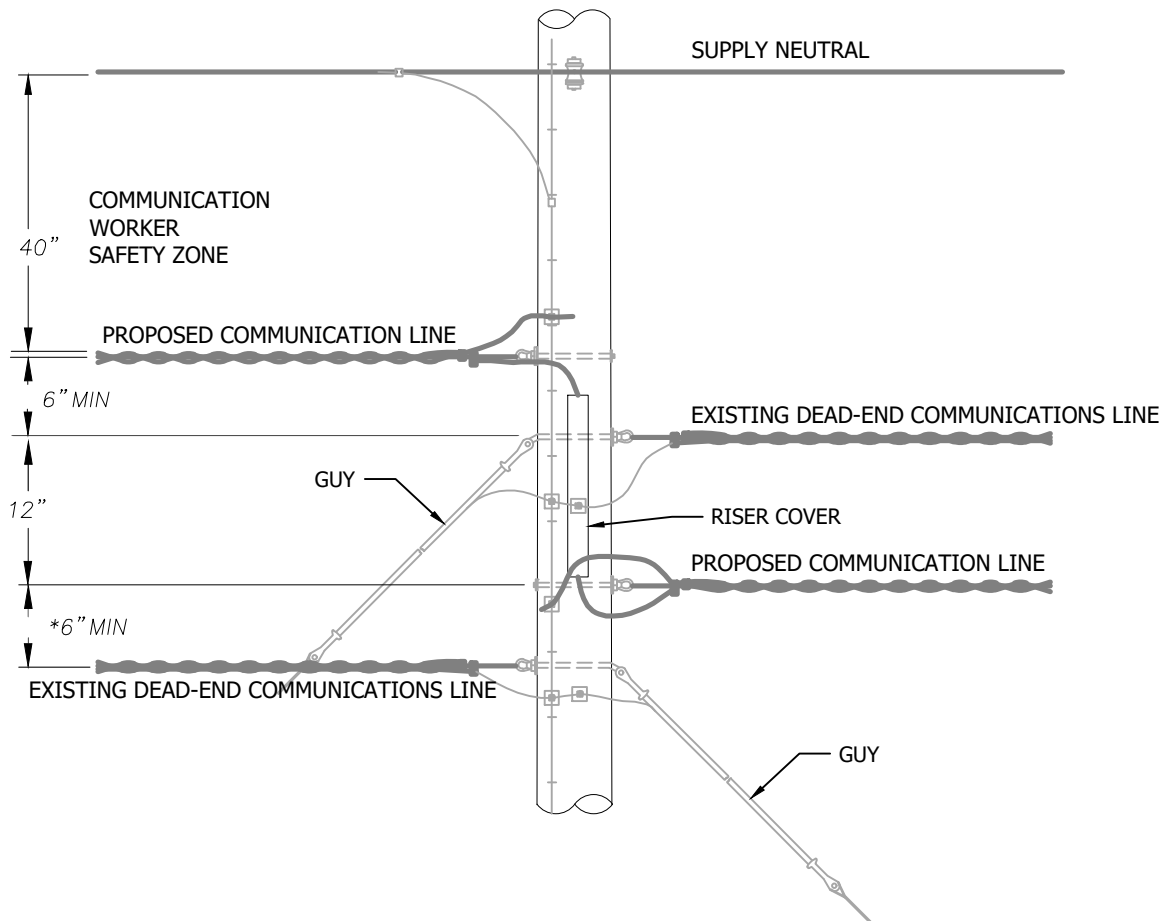

\* A MINIMUM OF 6 INCH VERTICAL CLEARANCE SHALL BE MAINTAINED BETWEEN THROUGH BOLTS.

MEDINA ELECTRIC COOPERATIVE  
 PO Box 370  
 Hondo, TX 78861

COMM LINE TRANSITION  
 ON DEAD END POLE

REV	DATE	REVISION DESCRIPTION	DESIGNER	REVIEWER	NOT TO SCALE
A	11/24/21	INITIAL	MAP	TAF	



DRAWING #  
 MEC-12

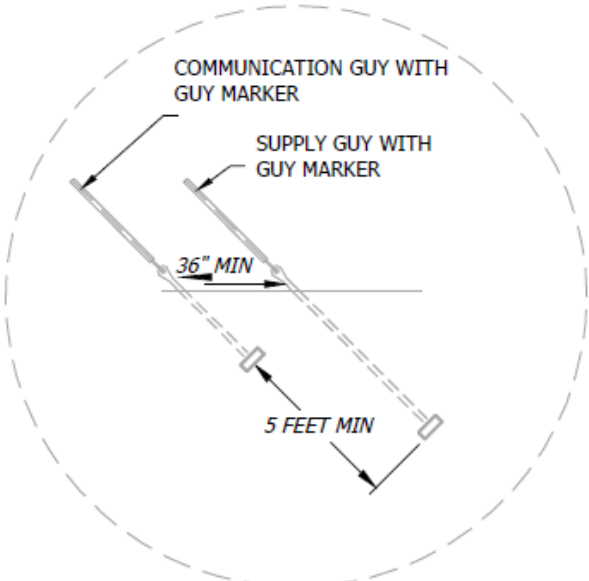
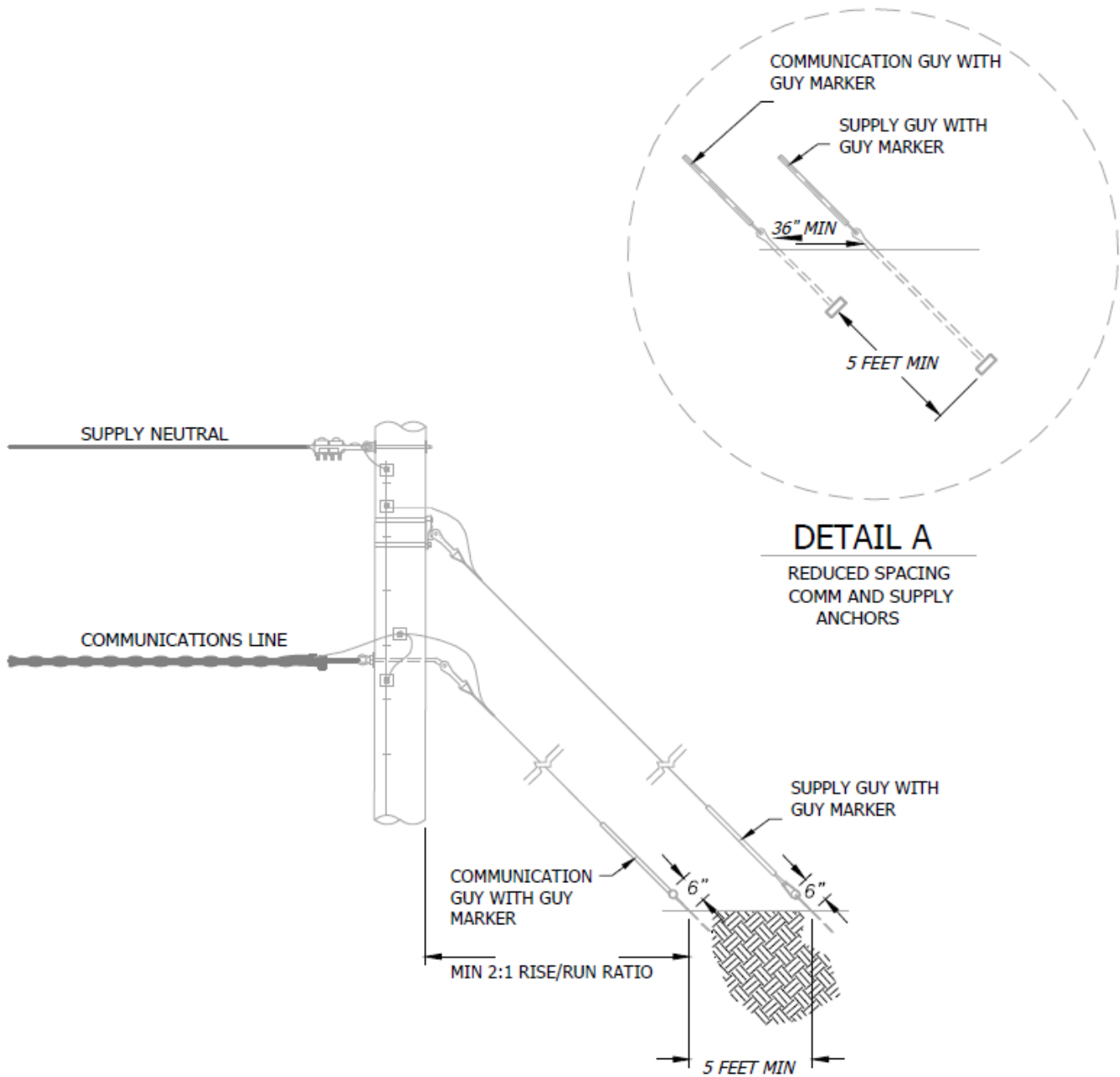

**DETAIL A**

REDUCED SPACING  
COMM AND SUPPLY  
ANCHORS

MEDINA ELECTRIC COOPERATIVE  
PO Box 370  
Hondo, TX 78861

SUPPLY AND COMM DOWN GUYS  
AND ANCHORS

REV	DATE	REVISION DESCRIPTION	DESIGNER	REVIEWER	NOT TO SCALE
A	11/24/21	INITIAL	MAP	TAF	



DRAWING #

MEC-13



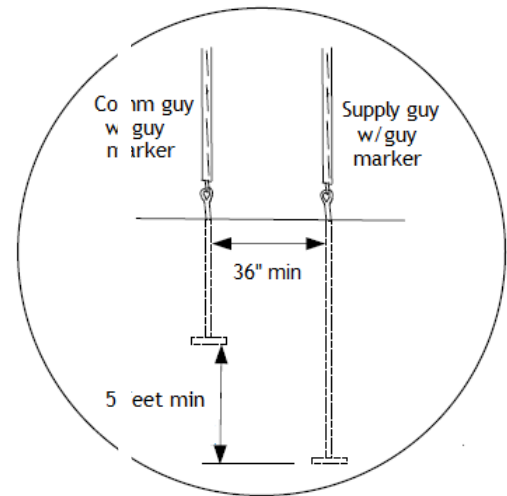
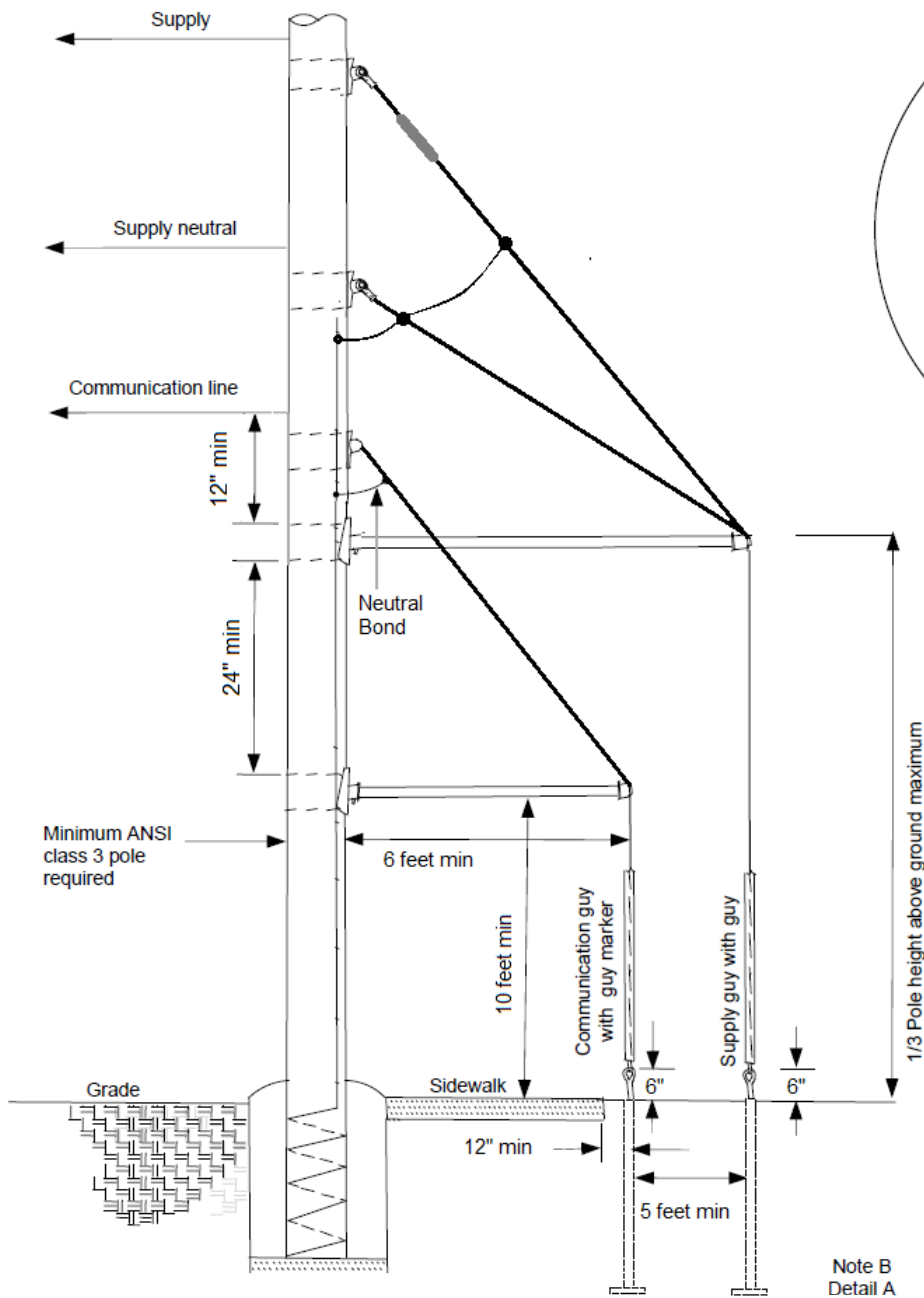



**Detail A**  
 Reduced spacing  
 Comm and Supply  
 Anchors

Note B  
 Detail A

INSTALL GUY LINK BEHIND SUPPLY CONDUCTOR OF SUFFICIENT LENGTH TO FALL BELOW NEUTRAL IF GUY IS BROKEN

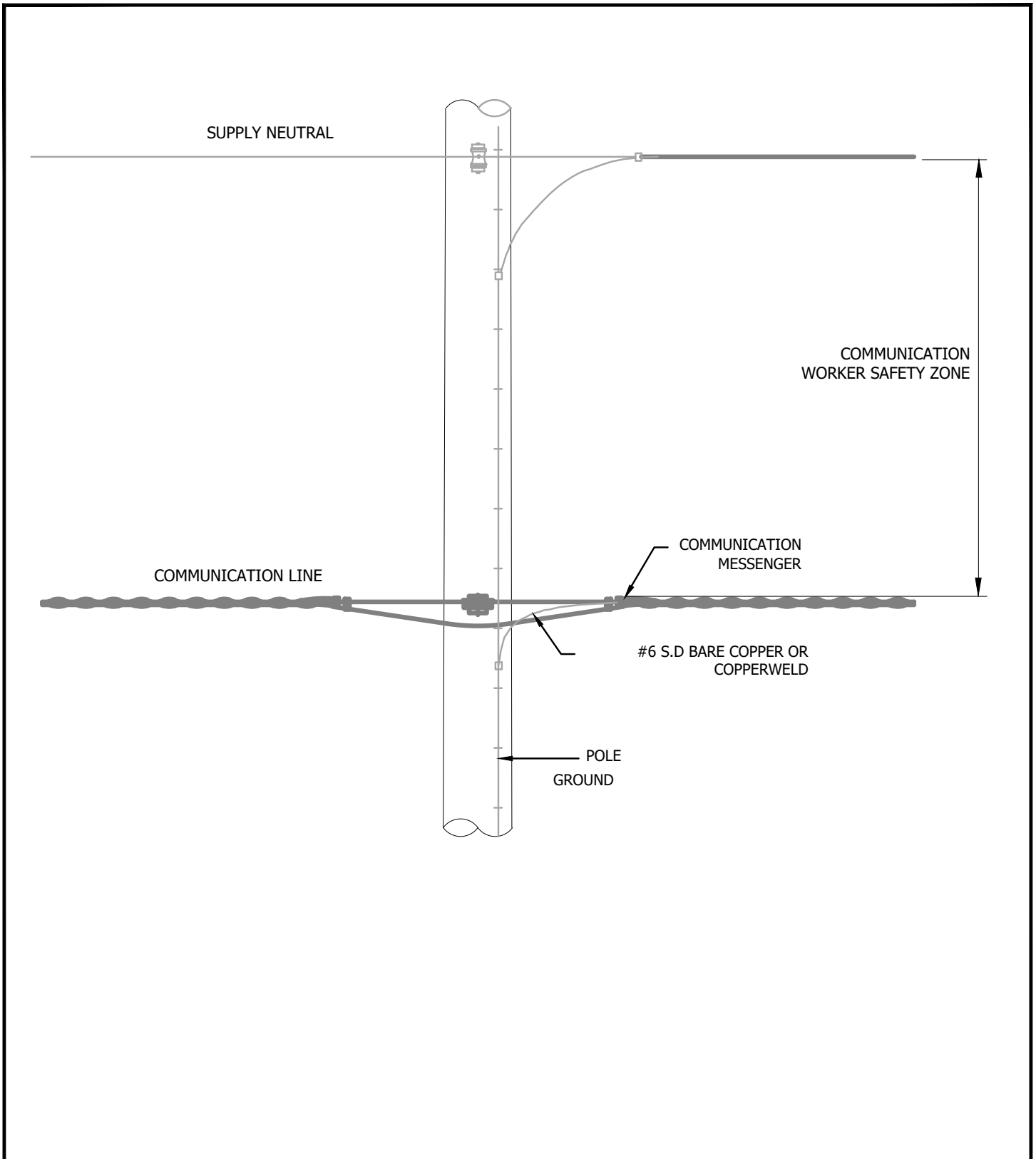
MEDINA ELECTRIC COOPERATIVE PO Box 370 Hondo, TX 78861					SUPPLY AND COMM SIDEWALK GUYS AND ANCHORS		
REV	DATE	REVISION DESCRIPTION	DESIGNER	REVIEWER	NOT TO SCALE		
A	11/24/21	INITIAL	MAP	TAF			
							DRAWING #
							MEC-14



MEDINA ELECTRIC COOPERATIVE PO Box 370 Hondo, TX 78861					COMMUNICATION LINE GROUNDING	
REV	DATE	REVISION DESCRIPTION	DESIGNER	REVIEWER	NOT TO SCALE	
A	11/24/21	INITIAL	MAP	TAF		
					DRAWING #	
					MEC-15	

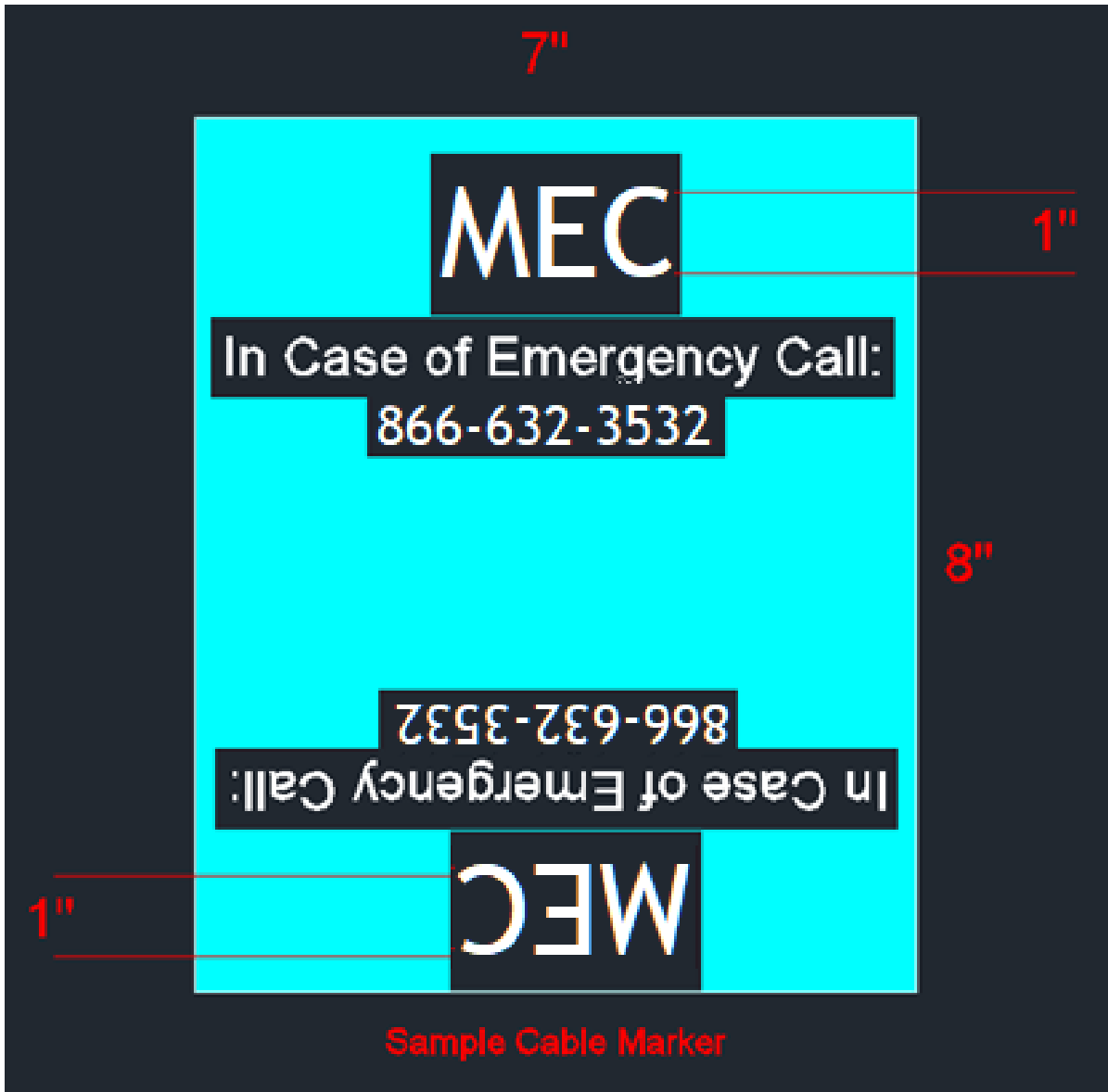

MEDINA ELECTRIC COOPERATIVE PO Box 370 Hondo, TX 78861					TAGGING ATTACHMENTS	
REV	DATE	REVISION DESCRIPTION	DESIGNER	REVIEWER	NOT TO SCALE	
A	11/24/21	INITIAL	MAP	TAF		DRAWING #
						MEC-16

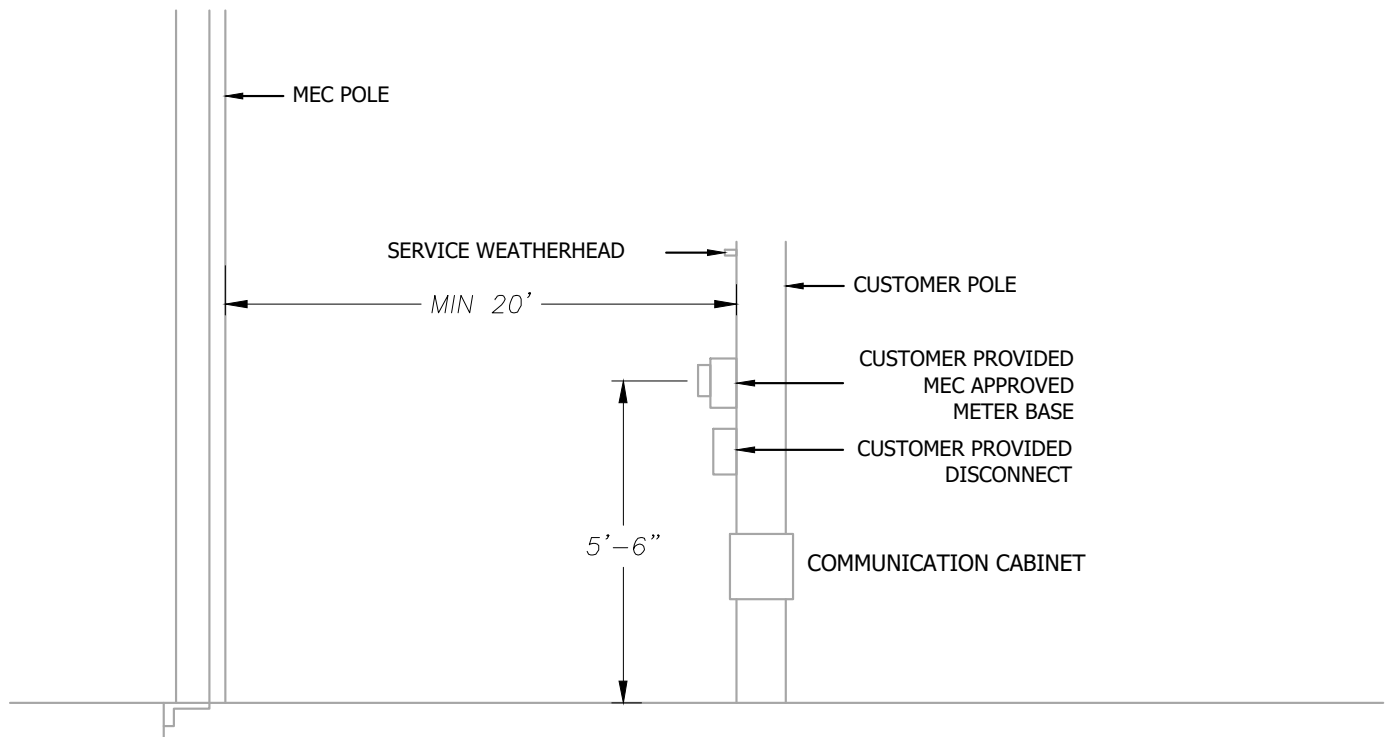

MEDINA ELECTRIC COOPERATIVE  
 PO Box 370  
 Hondo, TX 78861

INSTALLATIONS ON NEARBY  
 NON-MEC POLES

REV	DATE	REVISION DESCRIPTION	DESIGNER	REVIEWER	NOT TO SCALE
A	11/24/21	INITIAL	MAP	TAF	

DRAWING #

MEC-17

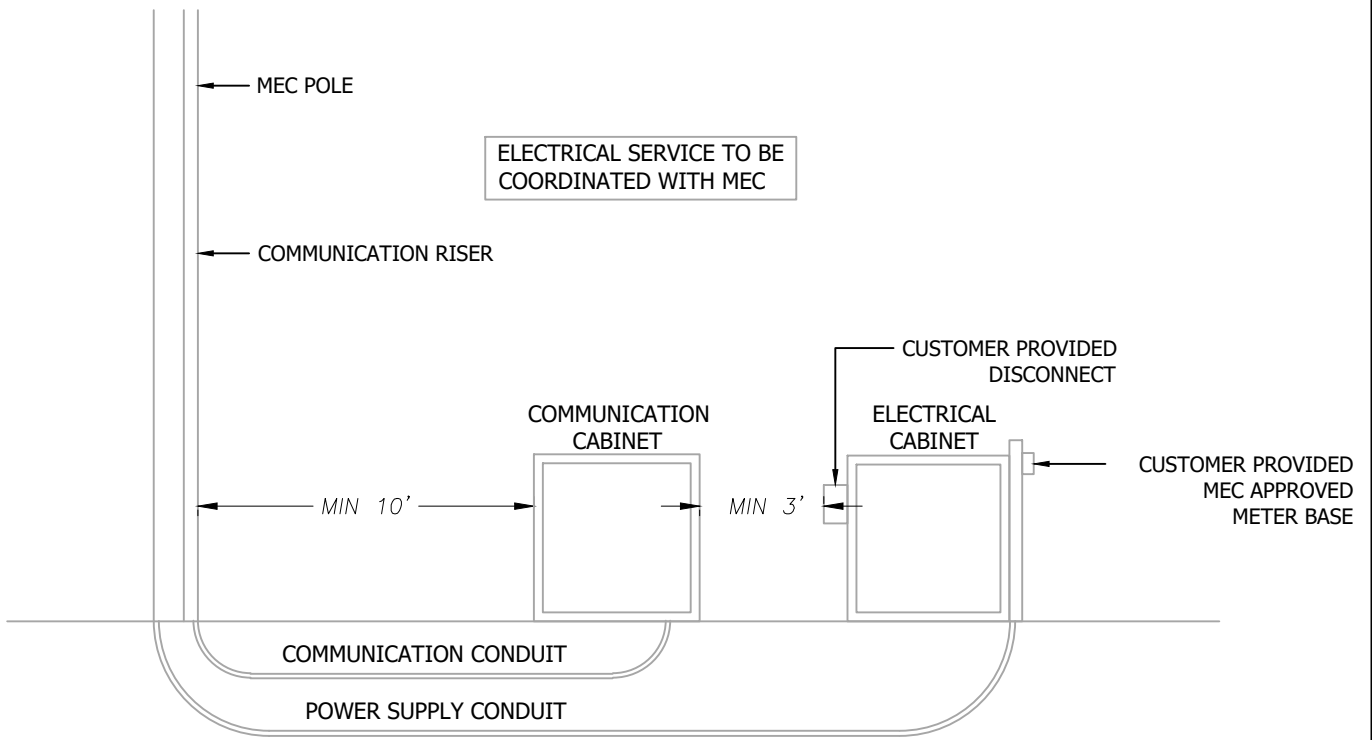

1. COMMUNICATION CABINET MUST BE EFFECTIVELY GROUNDED IN ACCORDANCE WITH THE CURRENT EDITION OF THE NESC
2. ALL ABOVE GROUND METALLIC SUPPLY AND COMMUNICATIONS ENCLOSURES SEPARATED BY A DISTANCE OF 6 FEET OR LESS SHALL BE BONDED TOGETHER IN ACCORDANCE WITH NESC RULE 384.

MEDINA ELECTRIC COOPERATIVE PO Box 370 Hondo, TX 78861					NON -POLE MOUNTED NEARBY COMMUNICATIONS EQUIPMENT	
REV	DATE	REVISION DESCRIPTION	DESIGNER	REVIEWER	NOT TO SCALE	
A	11/24/21	INITIAL	MAP	TAF		
					DRAWING #	
					MEC-18	

**Average Span**

Line Angle 0°-3°  
Line Angle 3°-8°  
Line Angle 8°-20°  
Line Angle 20°-30°  
Deadend (2838 lb Maximum)

		1/4" HS Messenger NESC Grade C					
	150	200	250	300	350	400	450
	H	H					
	H	H					
	H	H					G
	G	G					
	C	C					

		1/4" HS Messenger NESC Grade B					
	150	200	250	300	350	400	450
	H	H					
	H	H					
	G	G					
	G	G					
	C	C					

**Average Span**

Line Angle 0°-3°  
Line Angle 3°-8°  
Line Angle 8°-20°  
Line Angle 20°-30°  
Deadend (3600 lb Maximum)

		5/16" Utility Grade Messenger NESC Grade C					
	150	200	250	300	350	400	450
	H	H					
	H	H					
	H	G	G				
	G	G					
	C	C					

		5/16" Utility Grade Messenger NESC Grade B					
	150	200	250	300	350	400	450
	H	H					
	H	H					G
	G	G					
	G	G				F	F
	C	C					

**Average Span**

Line Angle 0°-3°  
Line Angle 3°-8°  
Line Angle 8°-20°  
Line Angle 20°-30°  
Deadend (5016 lb Maximum)

		3/8" HS Messenger NESC Grade C					
	150	200	250	300	350	400	450
	H	H					
	H	H				G	G
	G	G					
	G	G	G	F	F	F	E
	B	B					

		3/8" HS Messenger NESC Grade B					
	150	200	250	300	350	400	450
	H	H					
	H	H	H	G	G		
	G	G	E	E			
	E	E					
	B	B					

**Average Span**

Line Angle 0°-3°  
Line Angle 3°-8°  
Line Angle 8°-20°  
Line Angle 20°-30°  
Deadend (8700 lb Maximum)

		7/16" HS Messenger NESC Grade C					
	150	200	250	300	350	400	450
	H	H					
	G	G			F	G	G
	E	E					
	E	E					
	B	B					

		7/16" HS Messenger NESC Grade B					
	150	200	250	300	350	400	450
	H	H					
	G	G					
	E	E					
	B	B					
	B	B					

Attachment Designation	Number of Bands	Required Banding	Ultimate Strength	Attachment Allowable Strength	Attachment Type	Attachment Catalog Number	Buckle Catalog Number	Manufacturer
A	4	.044" x 1.25"	24700	20007	Pole Eye	BGA S25	BAB 58	Aluma-Form
B	2	.044" x 1.25"	20000	16200	Pole Eye	BGA S20	BAB 58	Aluma-Form
C	2	.044" x 1.25"	6900	5589	Pole Eye	BGA	BAB 58	Aluma-Form
D	2	.03" x .75"	2800	2268	Pole Eye	BGA	BAB 38	Aluma-Form
E	2	.044" x 1.25"	8400	6804	Clevis	HDBB	BAB 58	Aluma-Form
F	2	.03" x .75"	4100	3321	Clevis	HDBB	BAB 38	Aluma-Form
G	2	.044" x 1.25"	4800	3888	5/8" Stud	BB	BAB 58	Aluma-Form
H	2	.03" x .75"	2300	1863	5/8" Stud	BB	BAB 38	Aluma-Form

MEDINA ELECTRIC COOPERATIVE  
PO Box 370  
Hondo, TX 78861

**BANDING MATERIAL GUIDE**

REV	DATE	REVISION DESCRIPTION	DESIGNER	REVIEWER	NOT TO SCALE	DRAWING #
A	11/24/21	INITIAL	MAP	TAF		<p>MEC-19</p>